

**AUF DIE
PLÄTZE,
FERTIG,
SPIELEN!**



SEILFABRIK ULLMANN
Usacord

AUF DIE PLÄTZE, FERTIG, SPIELEN!

READY, STEADY, PLAY!

ULLMANN GROUP – GEBALLTE SEILKOMPETENZ IN 4. GENERATION

Die Schweizer Ullmann Group gehört mit ihren 7 Standorten und 3 Produktionsstätten sowie über 6 Mio. produzierten Seilm Metern im Monat zu den weltweit führenden Seilherstellern. Ob im Bau- und Industriebereich, in der Architektur, im Wassersport oder auf Spielplätzen – das innovative Schweizer Familienunternehmen steht bereits in vierter Generation für Qualität und grenzenlose Seiltechnologie.

SEILFABRIK ULLMANN – VERANTWORTUNG FÜR QUALITÄT, DIE BEGEISTERT

Das Herz der »Ullmänner« am Standort Bremen schlägt für die Entwicklung, Produktion und den Handel von hochwertigen und langlebigen Spielplatzgeräten mit attraktivem Spielwert. Viele Jahre Erfahrung, ein mitdenkendes und motiviertes Team sowie eine gute Unternehmenskultur fördern ein starkes Servicebewusstsein – und davon profitieren unsere Kunden in der ganzen Welt jeden Tag.

QUALITÄT UND KUNDENORIENTIERUNG IN ALLEN FACETTEN:

- Innovative Produktvielfalt
- Flexible Fertigung nach individuellen Wünschen
- Stetige Termin- und Liefertreue
- Hohe Produktionskapazität
- Einhaltung höchster Sicherheitsstandards
- Vertrauensvolle Zusammenarbeit und technischer Support

ULLMANN GROUP - FULL ROPE COMPETENCE IN THE 4TH GENERATION

The Swiss Ullmann Group is with 7 locations and 3 production sites, as well as over 6 million metres of rope produced per month, one of the world's leading rope manufacturers. Whether in the construction and industrial sectors, in architecture, in water sports or on playgrounds - the innovative Swiss family-owned company, now in its fourth generation, stands for quality and boundless rope technology.

SEILFABRIK ULLMANN – INSPIRING QUALITY

The heart of the »Ullmänner« at the Bremen location beats for the development, production and trade of high-quality and durable playground equipment with attractive play value. Many years of experience, a proactive and motivated team, as well as a good company culture promote a strong awareness of service - and our customers all over the world benefit from this every day.

QUALITY AND CUSTOMER ORIENTATION IN ALL FACETS:

- Innovative product variety
- Flexible production according to individual demands
- Continuous adherence to delivery dates and deadlines
- High production capacity
- Compliance with the highest safety standards
- Trustful cooperation and technical support



SPIELPLATZGERÄTE VON ULLMANN – AUF DIE PLÄTZE, FERTIG, SPIELEN!

Gemeinsam mit unseren Mitarbeiterinnen und Mitarbeitern tun wir alles, um die Erwartungen unserer Kunden zu übertreffen und Kindern auf der ganzen Welt »Magic Moments« zu bieten. Mit unseren Kletterpyramiden und -türmen, Nestschaukeln, Sprungeräten und Kletternetzen schaffen wir Freiraum für Bewegung und aktives Spiel.

PLAYGROUND EQUIPMENT FROM ULLMANN – READY, STEADY, PLAY!

Together with our employees, we do everything we can to exceed our customers' expectations and to offer "Magic Moments" to children all over the world. With our climbing pyramids and towers, nest swings, bouncing elements and climbing nets we create space for movement and active play.

WARUM SPIELPLATZGERÄTE VON DER SEILFABRIK ULLMANN?

- Hochwertige Materialien, wie unser Usacord-Longlife- und Herkules-Tauwerk
- Lebendige Farbvielfalt, individuell kombinierbar
- Lange Halt- und Bepielbarkeit durch erstklassige Verarbeitung
- Sehr gutes Preis-Leistungsverhältnis
- Hoher Spielwert
- Montage-, wartungs-, und reparaturfreundlich
- Geprüft und international zertifiziert

WHY PLAYGROUND EQUIPMENT FROM SEILFABRIK ULLMANN?

- High-quality materials, such as our Usacord Longlife and Herkules ropes
- Lively variety of colours, individually combinable
- Long durability and playability due to first-class workmanship
- Very good value for money
- High fun factor
- Easy to assemble, maintain and repair
- Tested and internationally certified



USACORD-SEILTECHNIK – SWISS QUALITY, ENGINEERED IN GERMANY

Spielgeräte müssen sicher sein! Nur wenn sie robust und langlebig sind, können Kinder jeden Alters unbeschwert klettern, entdecken und spielen. Daher gelten für all unsere Spielgeräte neben den internationalen Standards unsere eigenen, hohen Qualitätsanforderungen. Mit zahlreichen Patenten steht die Schweizer Usacord-Seiltechnik für höchste Qualität bis ins Detail.

USACORD ROPE TECHNOLOGY - SWISS QUALITY, ENGINEERED IN GERMANY

Playground equipment has to be safe! Only if it is robust and durable, children of all ages can carefree climb, discover and play. That is why our own high quality standards apply to all our playground equipment, in addition to the international standards. With numerous patents, the Swiss Usacord rope technology stands for highest quality in every detail.

- Alle Spielgeräte der Seilfabrik Ullmann sind zertifiziert, geprüft und tragen das TÜV-Zeichen
- Gütesiegel des BSFH, Bundesverband für Spielplatzgeräte- und Freizeitanlagen-Hersteller
- Mitglied der International Play Equipment Manufacturers Association (IPEMA)
- Qualitätsmanagement international zertifiziert ISO 9001

- All of Seilfabrik Ullmann's playground equipment is certified, tested and bears the TÜV mark.
- Quality seal of BSFH (Bundesverband für Spielplatzgeräte- und Freizeitanlagen-Hersteller)
- Member of the International Play Equipment Manufacturers Association (IPEMA)
- Quality Management internationally certified ISO 9001





ENTDECKER GESUCHT

LOOKING FOR EXPLORERS

DREHBARE KLETTERTÜRME
REVOLVING CLIMBING TOWERS

10 - 21

KLETTERPYPAMIDEN | 0,95 M FALLHÖHE
CLIMBING PYRAMIDS | 0.95 M FALL HEIGHT

22 - 33

KLETTERPYPAMIDEN KLASSIK
CLIMBING PYRAMIDS CLASSIC

34 - 37

SCHAUKELN
SWINGS

38 - 56

FEDERWIPPENEST
ROCKING SEESAW-NET

57

HÄNGEMATTEN + TEPPICHE
HAMMOCKS + CARPETS

58 - 61

SPRUNGERÄTE
BOUNCING ELEMENTS

62 - 75

NETZE, BRÜCKEN, SEILE & ZUBEHÖR
NETS, BRIDGES, ROPES & ACCESSORIES

76 - 87

FREIZEITSPORT
FUN SPORT

88 - 89

INFORMATIONEN

INFORMATION

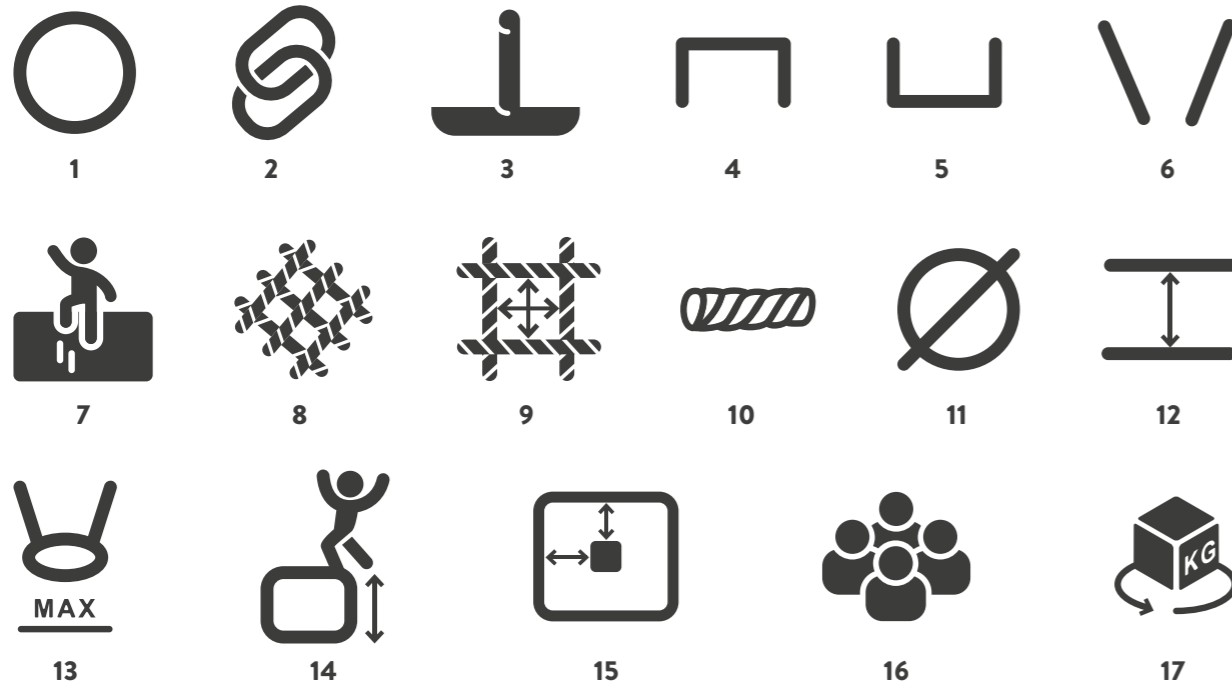

1 RING
RING

2 VERBINDUNGSTEILE
CONNECTING PARTS

3 PFOSTEN
POST

4 OBERRAHMEN
UPPER FRAME

5 UNTERRAHMEN
LOWER FRAME

6 AUFHÄNGESEILE
SUSPENSION ROPES

7 SPRUNGFLÄCHE
BOUNCING AREA

8 NETZ
NET

9 MASCHENGRÖSSE
MESH SIZE

10 TAU
ROPE

11 GERÄTERAUM
PLAY STRUCTURE
DIMENSIONS

12 GERÄTEHÖHE
DEVICE HEIGHT

13 MAX. AUFHÄNGEHÖHE
MAX. SUSPENSION HEIGHT

14 MAX. FREIE FALLHÖHE
MAX. FALLING HEIGHT

15 MINDESTRAUM
USE ZONE

16 BENUTZERANGABEN
USER INFORMATION

17 VERSANDINFORMATIONEN
SHIPPING INFORMATION



DREHBARE KLETTERTÜRME

REVOLVING CLIMBING TOWERS

DAS HIGHLIGHT AUF DEM SPIELPLATZ

Ringsherum und hoch hinaus – unsere drehbaren Klettertürme ziehen kleine Kletterfans magisch an. Beim Erobern der Türme lernen Kinder spielend und mit viel Freude neue Bewegungsabläufe, die ihnen helfen, ihre Motorik zu verbessern. Unsere Klettertürme sind langlebig, witterungsbeständig und nahezu unverwundlich. Hochwertige Herkules-Polyesterseile mit integrierter Stahllitze garantieren maximalen Schutz vor Vandalismus. Für Sicherheit beim Spielen sorgen höchste Qualitätsstandards bei allen verbauten Teilen. Je nach Modell verfügen unsere Klettertürme über Kletternetzringe, Sitzteller sowie Kletternetze – die Farbgestaltung ist sogar nach Kundenwunsch individualisierbar.

QUALITÄT FÜR DEN PROFESSIONELLEN EINSATZ:

- Reparaturfreundlich durch austauschbare Seile
- Vandalismussicher durch Herkules-Tauwerk
- Individuelle Farbgestaltung nach Kundenwunsch möglich
- Schneller und einfacher Aufbau
- Hervorragendes Preis-Leistungsverhältnis und kurze Lieferzeiten

THE ATTRACTION ON EVERY PLAYGROUND

Around and high up - our rotating climbing towers magically attract little climbing fans. While conquering the towers, children playfully and joyfully learn new movements that help them to improve their motor skills. Our climbing towers are durable, weatherproof and almost indestructible. High-quality Herkules polyester ropes with integrated steel strands guarantee maximum protection against vandalism. The highest quality standards for all installed parts ensure safety during play. Depending on the model, our climbing towers have climbing net rings, seat plates as well as climbing nets - the colour design can even be customised according to the customer's wishes.

QUALITY FOR PROFESSIONAL USE:

- Easy to repair due to replaceable ropes
- Vandalism-proof due to Hercules ropes
- Individual colour design possible according to customer requirements
- Quick and easy assembly
- Excellent value for money and short delivery times

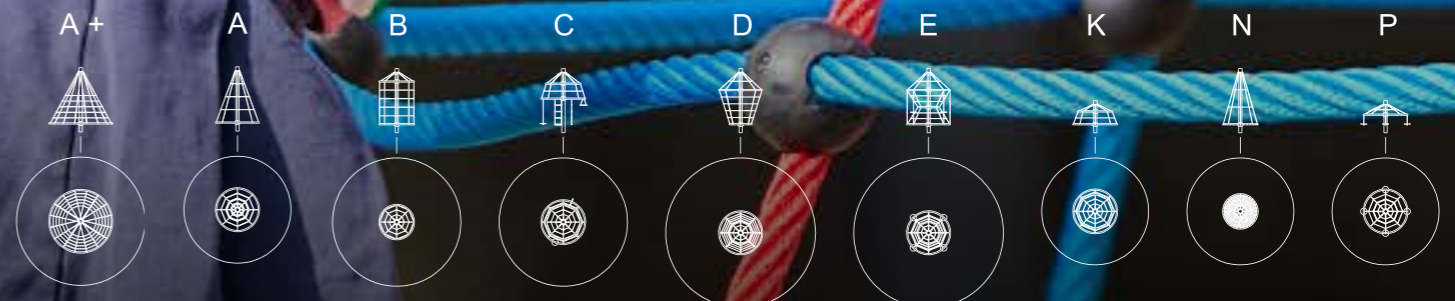

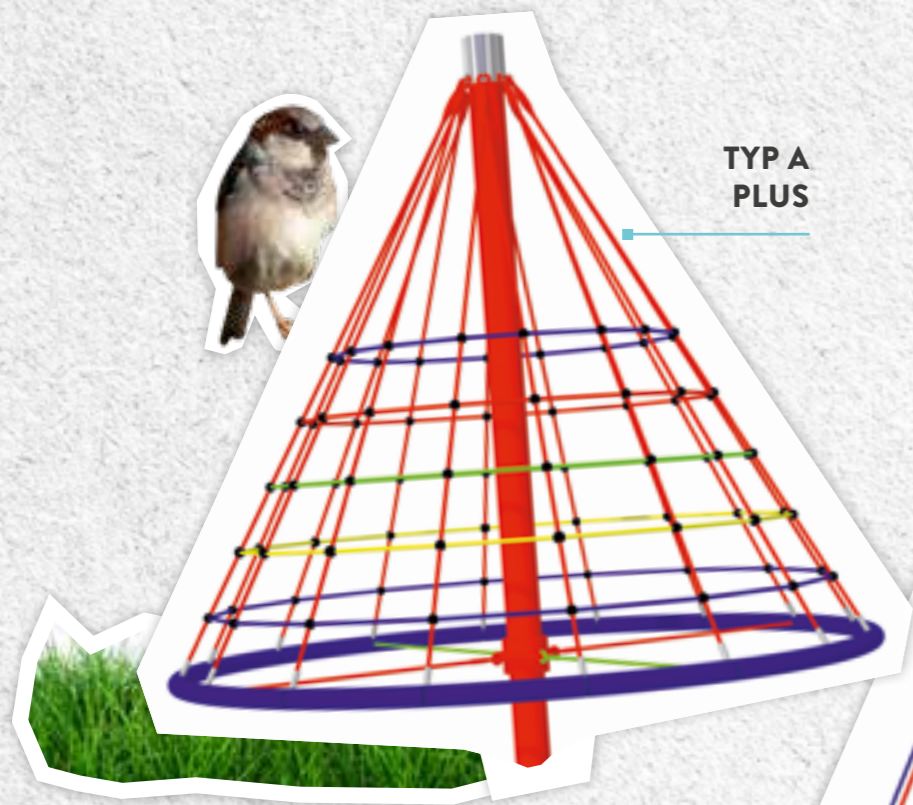

TYP A PLUS

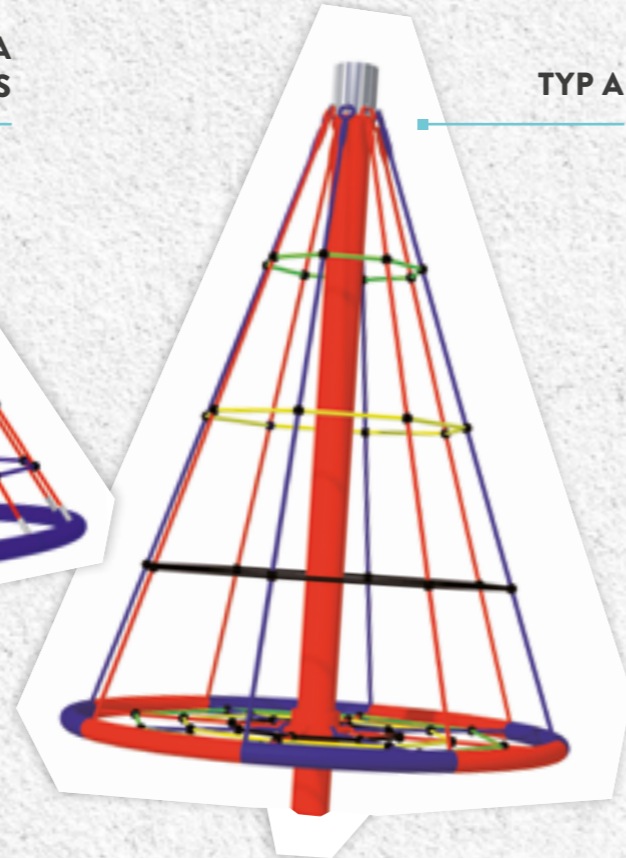

TYP A



TYP A
ART. 0101

TYP A PLUS
ART. 0101300

	Herkules (16 mm), 6-schäftig, PES mit Stahlseele 6-strand, PES with steel core
	152,4 x 4,5 x 3850 mm Stahlrohr, feuerverzinkt, pulverbeschichtet Steel pipe, hot-dip galvanised, powder-coated
	3,00 m
	3,00 m
	3-14 Jahre / Years 14 Benutzer / Users
	6,00 m
	2,10 m
	Netz & Ringe (Net & Rings): 85 kg, 300 x 30 x 300 cm Pfosten (Post): 75 kg, 385 x 25 x 25 cm

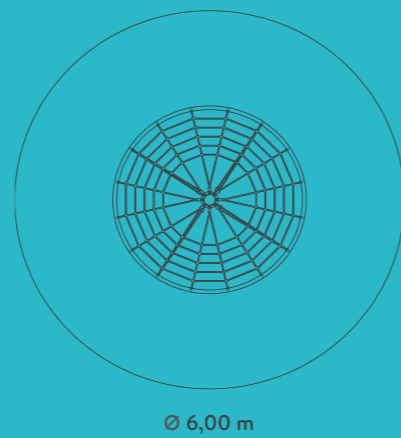
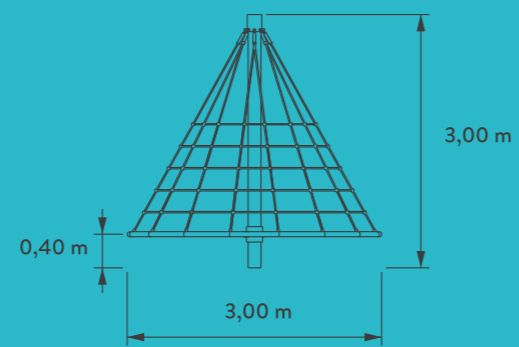

	Herkules (16 mm), 6-schäftig, PES mit Stahlseele 6-strand, PES with steel core
	152,4 x 4,5 x 3850 mm Stahlrohr, feuerverzinkt, pulverbeschichtet Steel pipe, hot-dip galvanised, powder-coated
	3,00 m
	2,00 m
	3-14 Jahre / Years 7 Benutzer / Users
	5,00 m
	2,20 m
	Netz & Ringe (Net & Rings): 55 kg, 200 x 30 x 200 cm Pfosten (Post): 75 kg, 385 x 25 x 25 cm

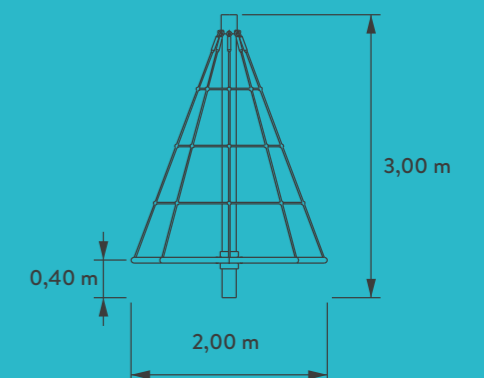



TYP B
ART. 0102



TYP C
ART. 0109

	Herkules (16 mm), 6-schäftig, PES mit Stahlseele 6-strand, PES with steel core
	152,4 x 4,5 x 3850 mm Stahlrohr, feuerverzinkt, pulverbeschichtet Steel pipe, hot-dip galvanised, powder-coated
	3,00 m Ø 1,60 m
	3-14 Jahre / Years 8 Benutzer / Users
	6,00 m
	2,20 m
	Netz & Ringe (Net & Rings): 75 kg, 160 x 30 x 160 cm Pfosten (Post): 75 kg, 385 x 25 x 25 cm

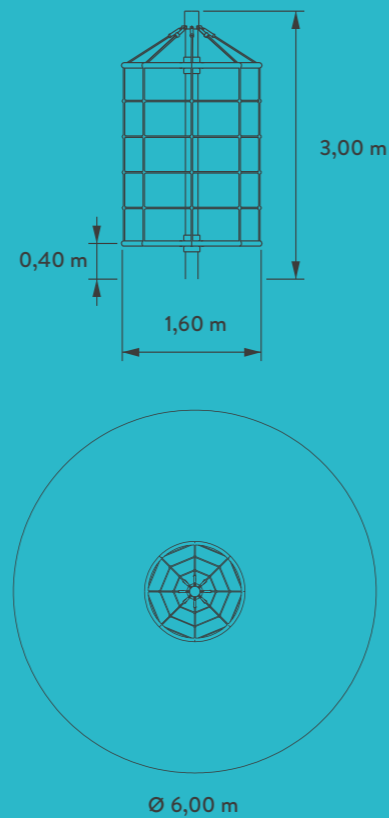

	Herkules (16 mm), 6-schäftig, PES mit Stahlseele 6-strand, PES with steel core
	152,4 x 4,5 x 3850 mm Stahlrohr, feuerverzinkt, pulverbeschichtet Steel pipe, hot-dip galvanised, powder-coated
	3,00 m Ø 2,00 m
	3-14 Jahre / Years 10 Benutzer / Users
	6,00 m
	2,30 m
	Netz & Ringe (Net & Rings): 80 kg, 200 x 30 x 200 cm Pfosten (Post): 75 kg, 385 x 25 x 25 cm

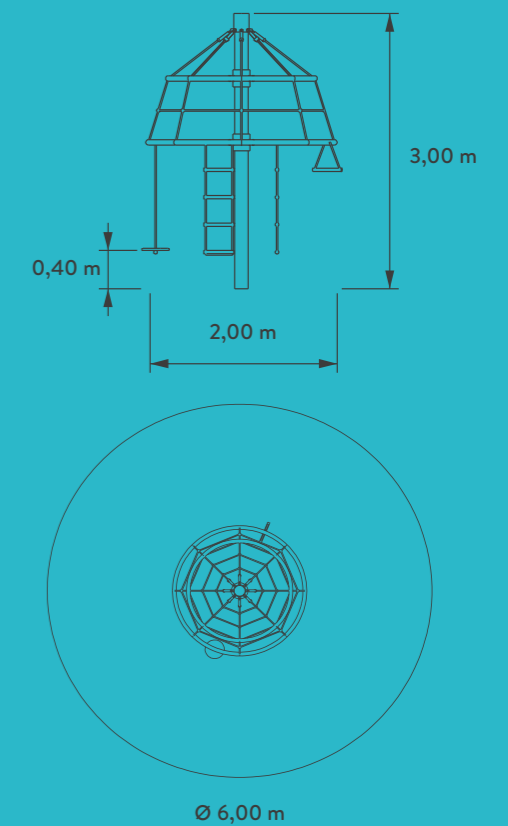



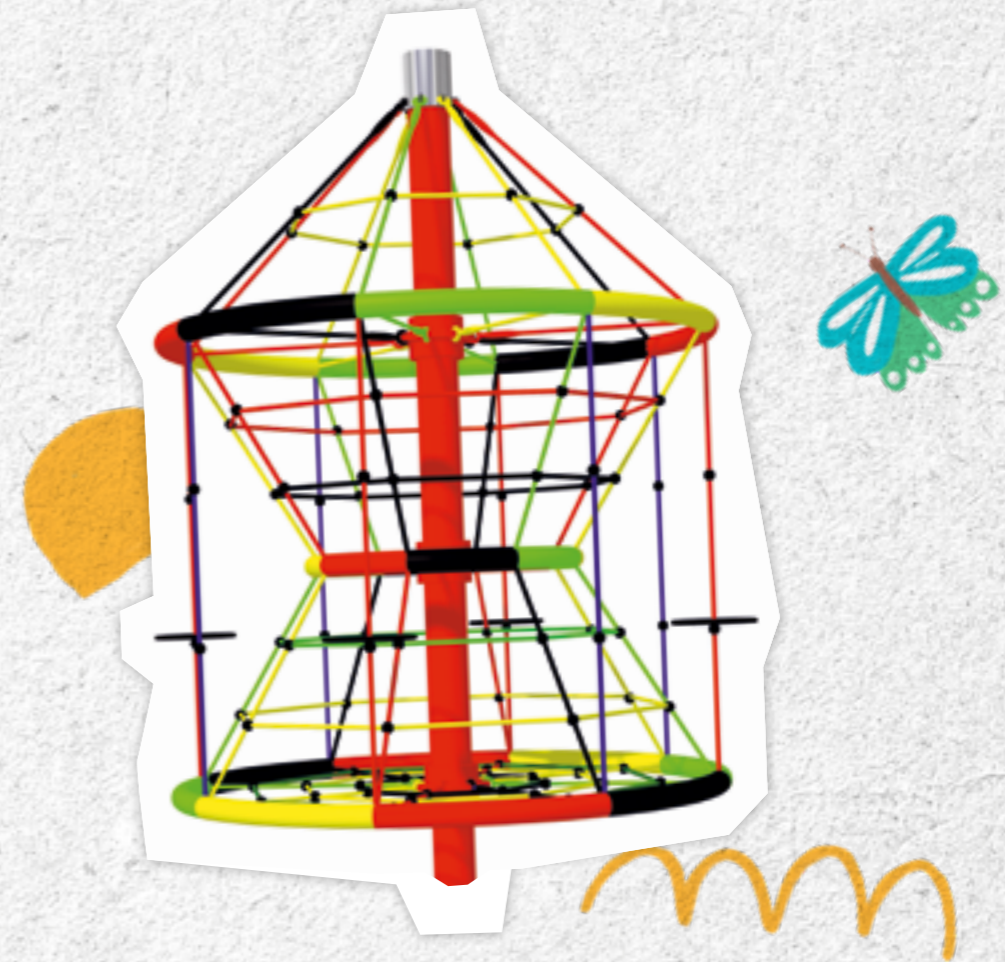

TYP D
ART. 0103

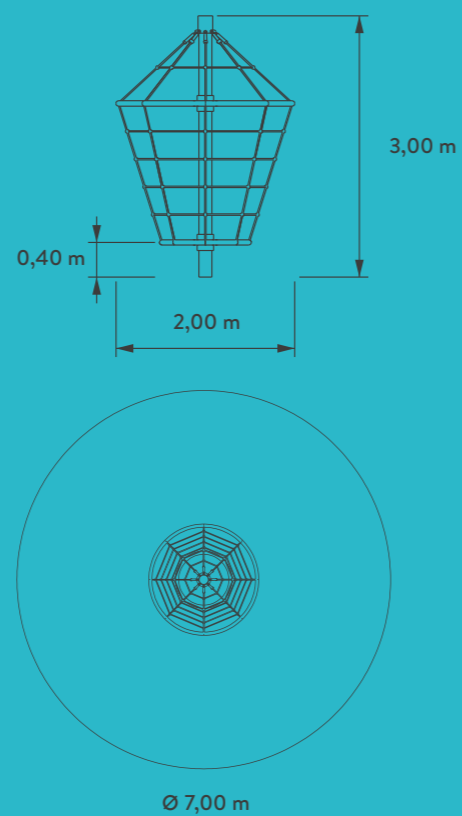

TYP E
ART. 0104

	Herkules (16 mm), 6-schäftig, PES mit Stahlseele 6-strand, PES with steel core
	152,4 x 4,5 x 3850 mm Stahlrohr, feuerverzinkt, pulverbeschichtet Steel pipe, hot-dip galvanised, powder-coated
	3,00 m  2,00 m
	3-14 Jahre / Years 10 Benutzer / Users
	7,00 m
	2,50 m
	Netz & Ringe (Net & Rings): 75 kg, 200 x 30 x 200 cm Pfosten (Post): 75 kg, 385 x 25 x 25 cm



	Herkules (16 mm), 6-schäftig, PES mit Stahlseele 6-strand, PES with steel core
	152,4 x 4,5 x 3850 mm Stahlrohr, feuerverzinkt, pulverbeschichtet Steel pipe, hot-dip galvanised, powder-coated
	3,00 m  2,00 m
	3-14 Jahre / Years 13 Benutzer / Users
	7,00 m
	2,50 m
	Netz & Ringe (Net & Rings): 120 kg, 200 x 30 x 200 cm Pfosten (Post): 75 kg, 385 x 25 x 25 cm

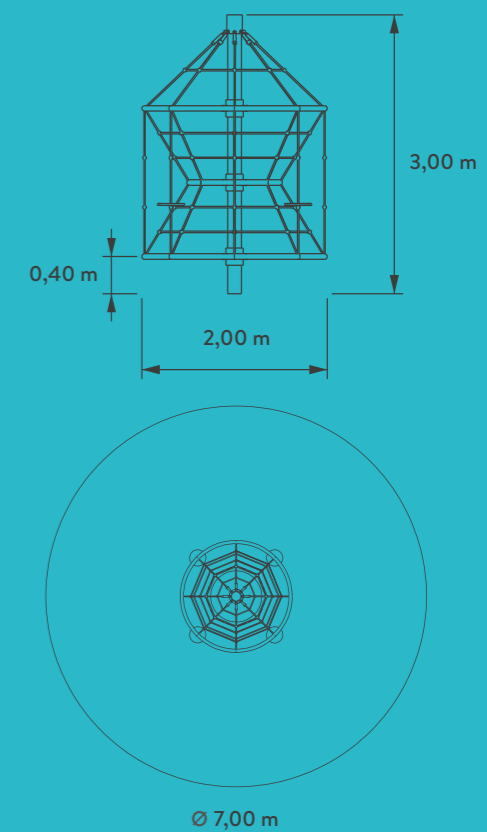



TYP K
ART. 0105

	Herkules (16 mm), 6-schäftig, PES mit Stahlseele 6-strand, PES with steel core
	152,4 x 4,5 x 2350 mm Stahlrohr, feuerverzinkt, pulverbeschichtet Steel pipe, hot-dip galvanised, powder-coated
	1,50 m 2,00 m
	3-14 Jahre / Years 5 Benutzer / Users
	5,00 m
	1,25 m
	Netz & Ringe (Net & Rings): 85 kg, 160 x 30 x 160 cm Pfosten (Post): 50 kg, 235 x 25 x 25 cm

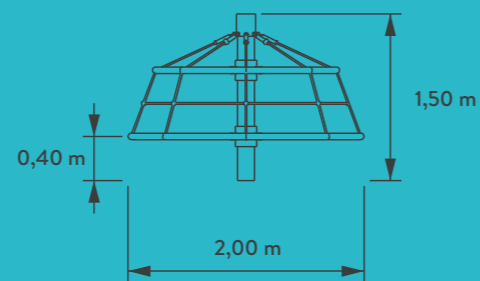





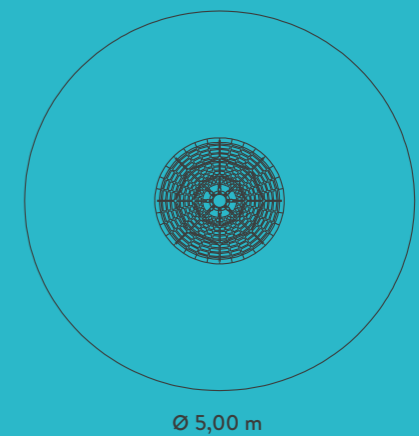
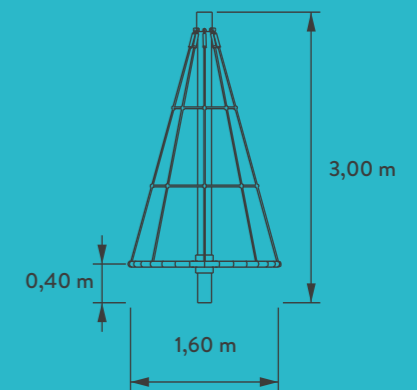

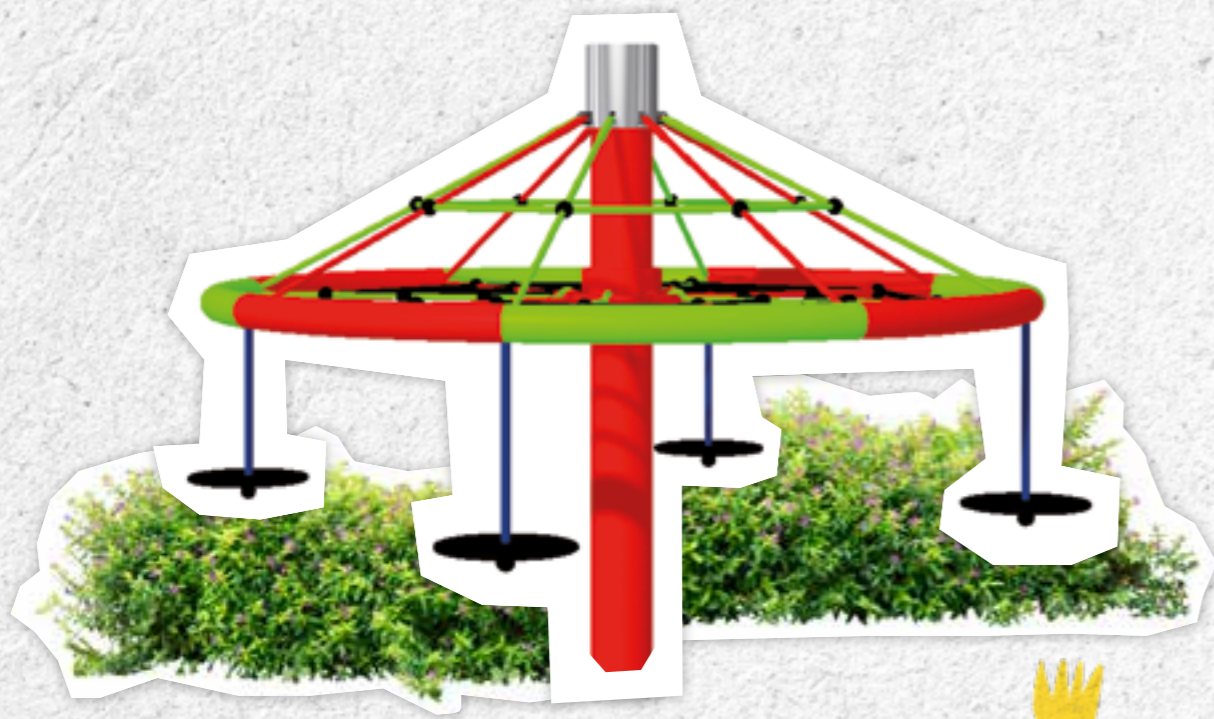

TYP N
ART. 0106

	Herkules (16 mm), 6-schäftig, PES mit Stahlseele 6-strand, PES with steel core
	152,4 x 4,5 x 3850 mm Stahlrohr, feuerverzinkt, pulverbeschichtet Steel pipe, hot-dip galvanised, powder-coated
	3,00 m 1,60 m
	3-14 Jahre / Years 4 Benutzer / Users
	5,00 m
	2,00 m
	Netz & Ringe (Net & Rings): 105 kg, 160 x 30 x 160 cm Pfosten (Post): 75 kg, 385 x 25 x 25 cm





TYP P
ART. 0108

	Herkules (16 mm), 6-schäftig, PES mit Stahlseele 6-strand, PES with steel core
	152,4 x 4,5 x 2350 mm Stahlrohr, feuerverzinkt, pulverbeschichtet Steel pipe, hot-dip galvanized, powder-coated
	1,50 m
	2,00 m
	3-14 Jahre / Years 8 Benutzer / Users
	5,00 m
	0,95 m
	Netz & Ringe (Net & Rings): 40 kg, 200 x 25 x 200 cm Pfosten (Post): 50 kg, 235 x 25 x 25 cm

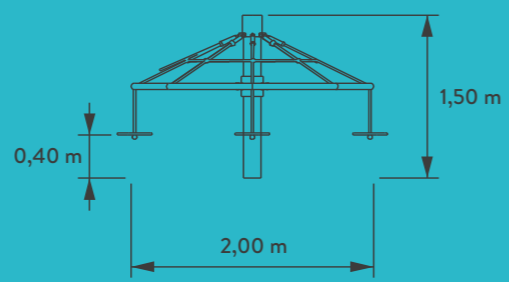

KLETTERPYRAMIDEN

CLIMBING PYRAMIDS

ABENTEUER FÜR GIPFELSTÜRMER!

Unsere Kletterpyramiden laden kleine und große Outdoorfans zum Erkunden und Spielen ein und sorgen für das perfekte Klettererlebnis – auch auf kleinstem Raum. Viele Klettermöglichkeiten bis in 7,5 m Höhe bieten Spielspaß und fördern Geschicklichkeit und Motorik. Die Pyramiden der neuesten Generation wurden so konstruiert, dass nur eine Fallhöhe von 0,95 m besteht. Somit können die Pyramiden sogar einfach auf Rasen oder Oberboden aufgestellt werden – ein zusätzlicher Fallschutz ist in der Regel nicht erforderlich. So wie all' unsere Spielgeräte sind unsere Kletterpyramiden mit der ausgefeilten Usacord-Seiltechnik hochwertig, langlebig und wartungsfreundlich – und überzeugen darüber hinaus mit farbenfrohen Designs.

GROSSE PRODUKTVIELFALT IN GEPRÜFTE QUALITÄT:

- Kein zusätzlicher Fallschutz erforderlich (neue Modelle, DIN EN 1176 beachten)
- Strukturierte Kletterwege und klare Spielebenen
- Große Modellvielfalt für unterschiedliches Raumangebot
- Austauschbare Seile sowie Ersatzverbinder als Zubehör
- Vandalismussicher durch Herkules-Tauwerk
- Individuelle Farbgestaltung nach Kundenwunsch

ADVENTURE FOR SUMMITTEERS!

Our climbing pyramids invite young and old outdoor fans to explore and play and provide the perfect climbing experience - even in the smallest of spaces. Many climbing possibilities up to a height of 7.5 m offer fun and encourage dexterity and motor skills. The pyramids of the latest generation have been designed in such a way that there is only a fall height of 0.95 m. This means that the pyramids can even be simply placed on grass or topsoil - additional fall protection is not usually required. Just like all our play equipment, our climbing pyramids with the sophisticated Usacord rope technology are high quality, durable and easy to maintain - and also impress with their colourful designs.

WIDE RANGE OF PRODUCTS IN TESTED QUALITY:



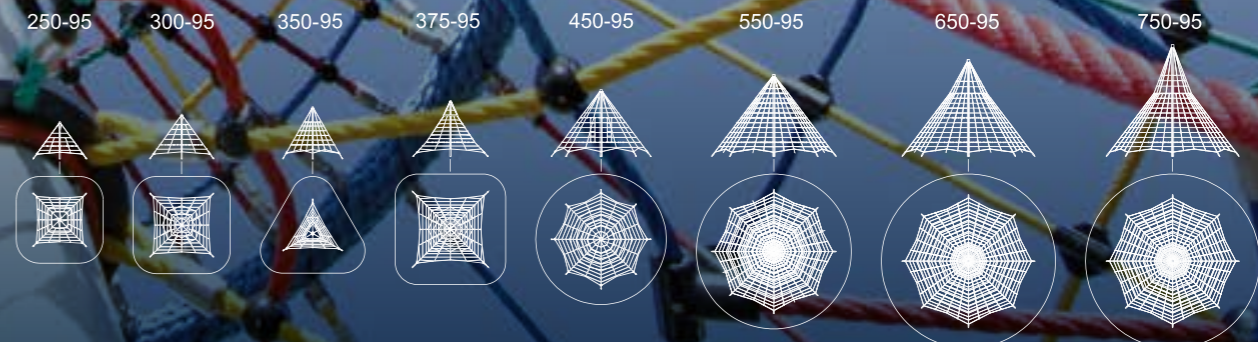

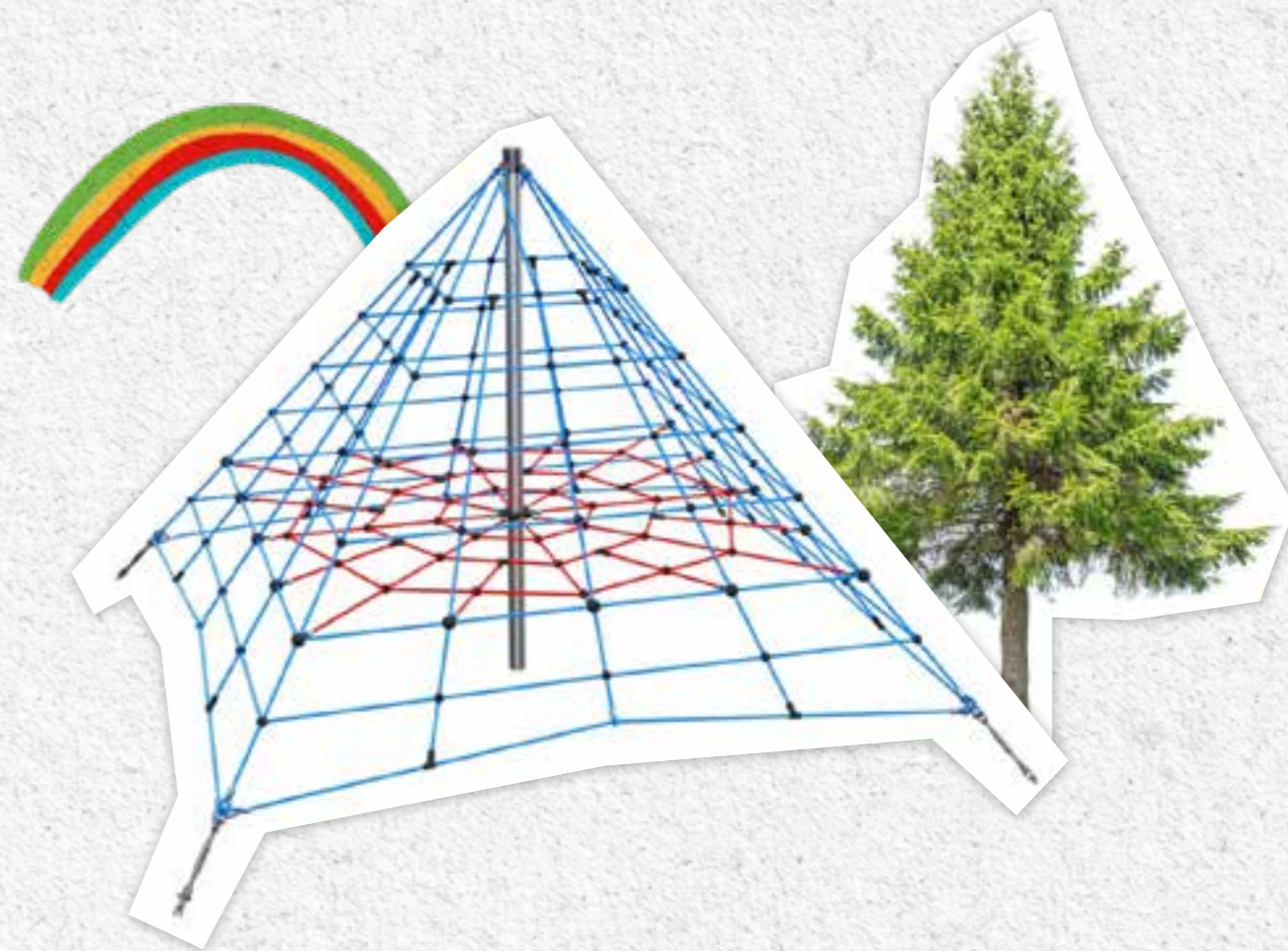
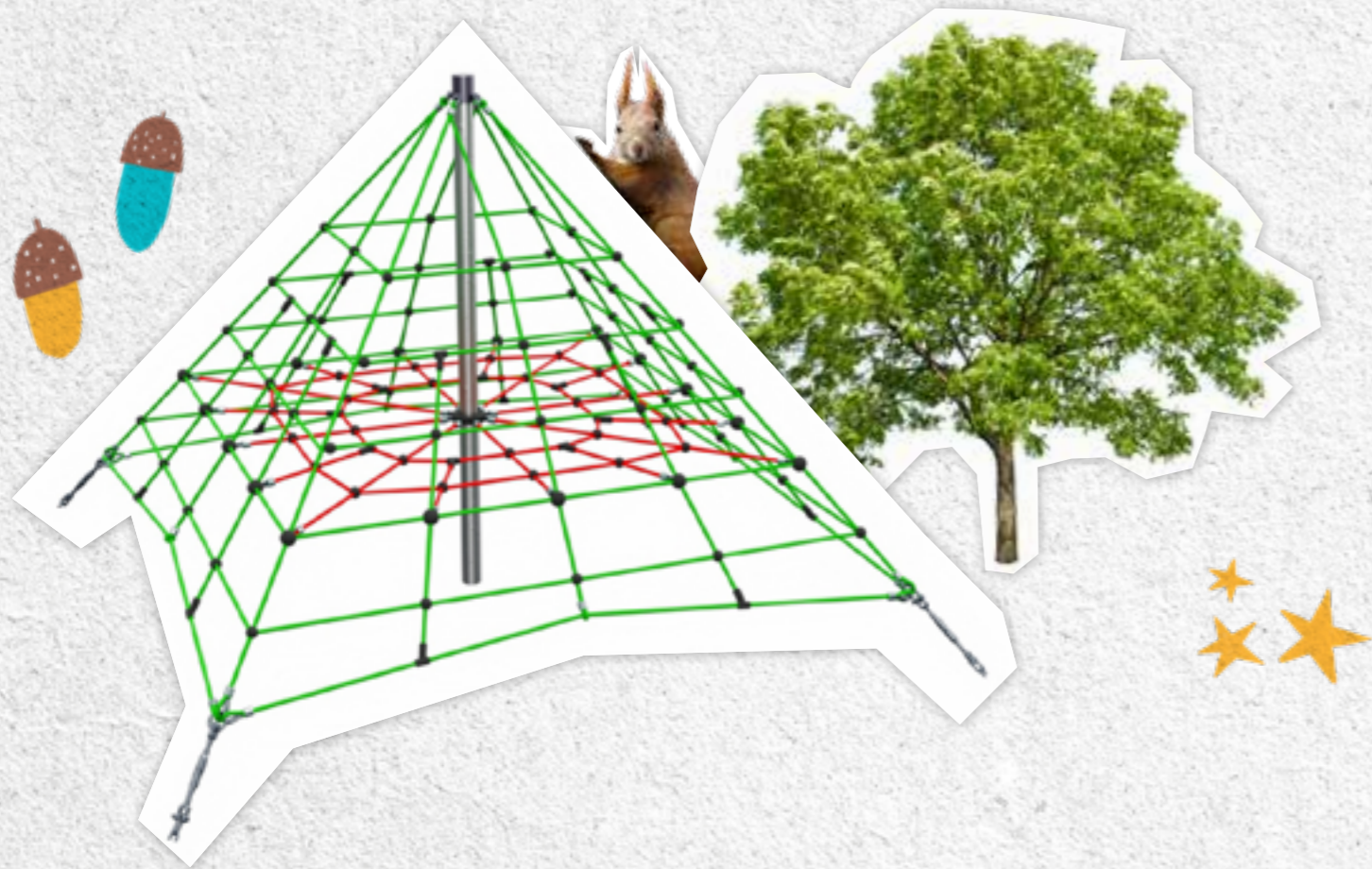
- No additional fall protection required (new models, observe DIN EN 1176).
- Structured climbing paths and clear play levels
- Large variety of models for different space requirements
- Exchangeable ropes and replacement connectors as accessories
- Vandalism-proof due to Herkules ropes
- Individual colour design according to customer requirements





TYP 250-95
ART. 01002509

TYP 300-95
ART. 01003009

	Herkules (16 mm), 6-schäftig, PES mit Stahlseele 6-strand, PES with steel core
	88,9 x 4 x 3350 mm Stahlrohr, feuerverzinkt Steel pipe, hot-dip galvanised
	2,50 m
	3,60 x 3,60 m
	0,95 m
	Wantenspanner M 16, feuerverzinkt M 16 turnbuckles, hot-dip galvanised
	3-10 Jahre / Years 18 Benutzer / User
	5,80 x 5,80 m
	Netz (Net): 50 kg, 80 x 60 x 60 cm Pfosten (Post): 25 kg, 335 x 10 x 10 cm

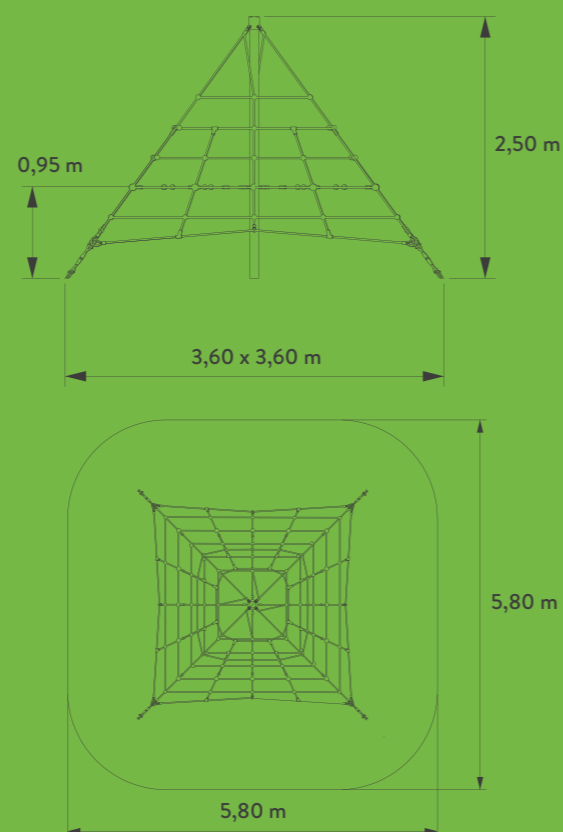

	Herkules (16 mm), 6-schäftig, PES mit Stahlseele 6-strand, PES with steel core
	88,9 x 4 x 3850 mm Stahlrohr, feuerverzinkt Steel pipe, hot-dip galvanised
	3,00 m
	4,30 x 4,30 m
	0,95 m
	Wantenspanner M 16, feuerverzinkt M 16 turnbuckles, hot-dip galvanised
	3-10 Jahre / Years 23 Benutzer / User
	6,50 x 6,50 m
	Netz (Net): 55 kg, 80 x 60 x 70 cm Pfosten (Post): 30 kg, 385 x 10 x 10 cm

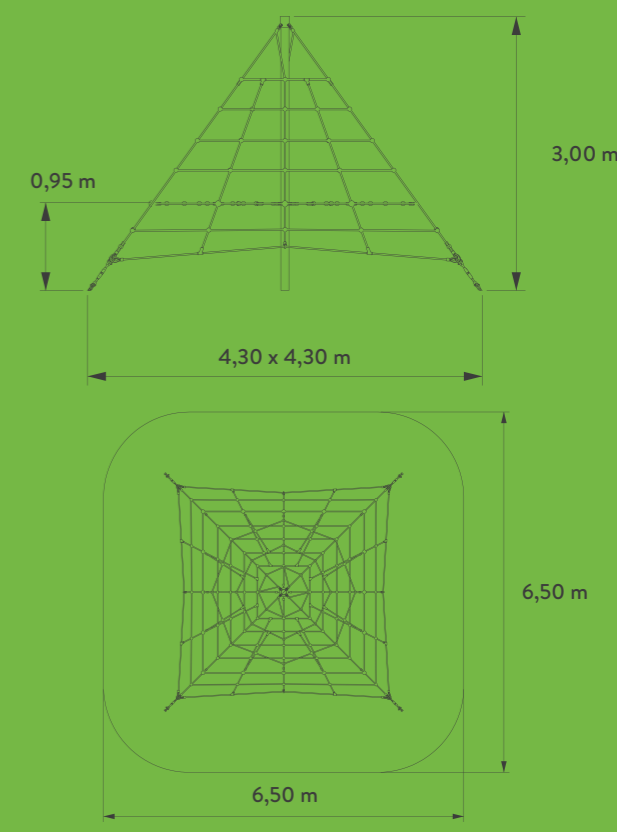

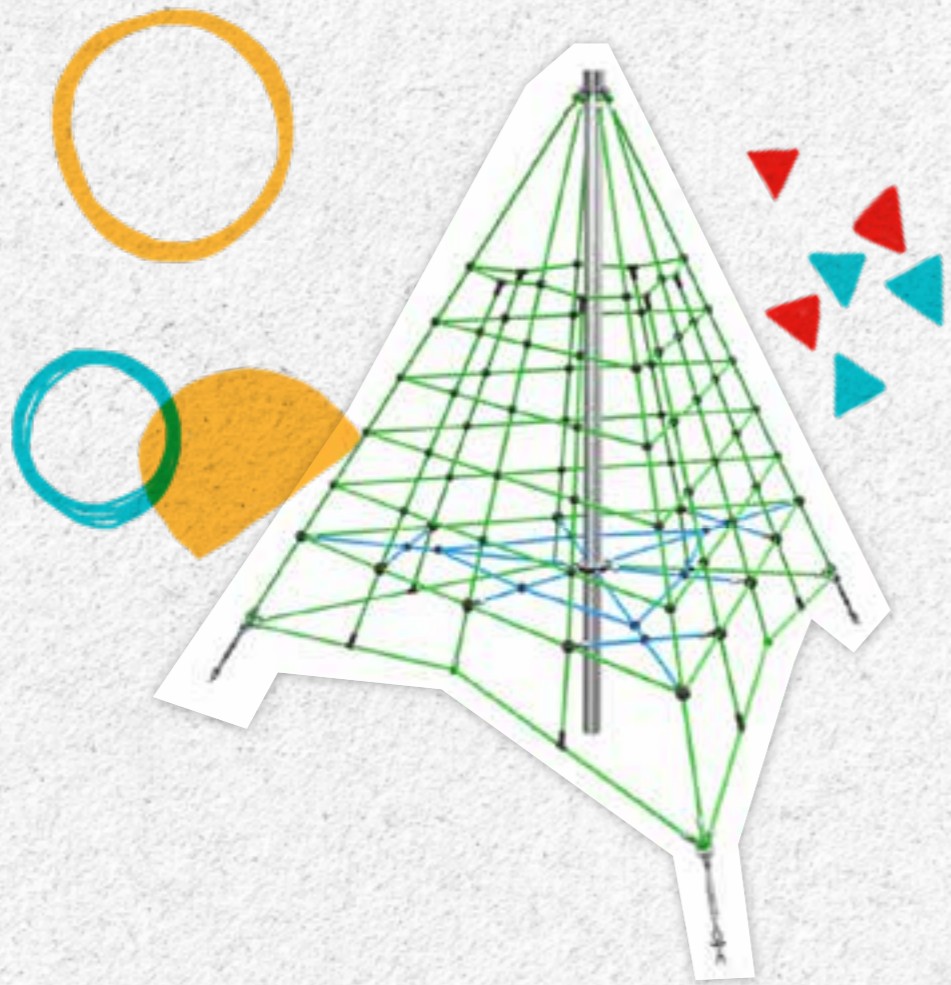

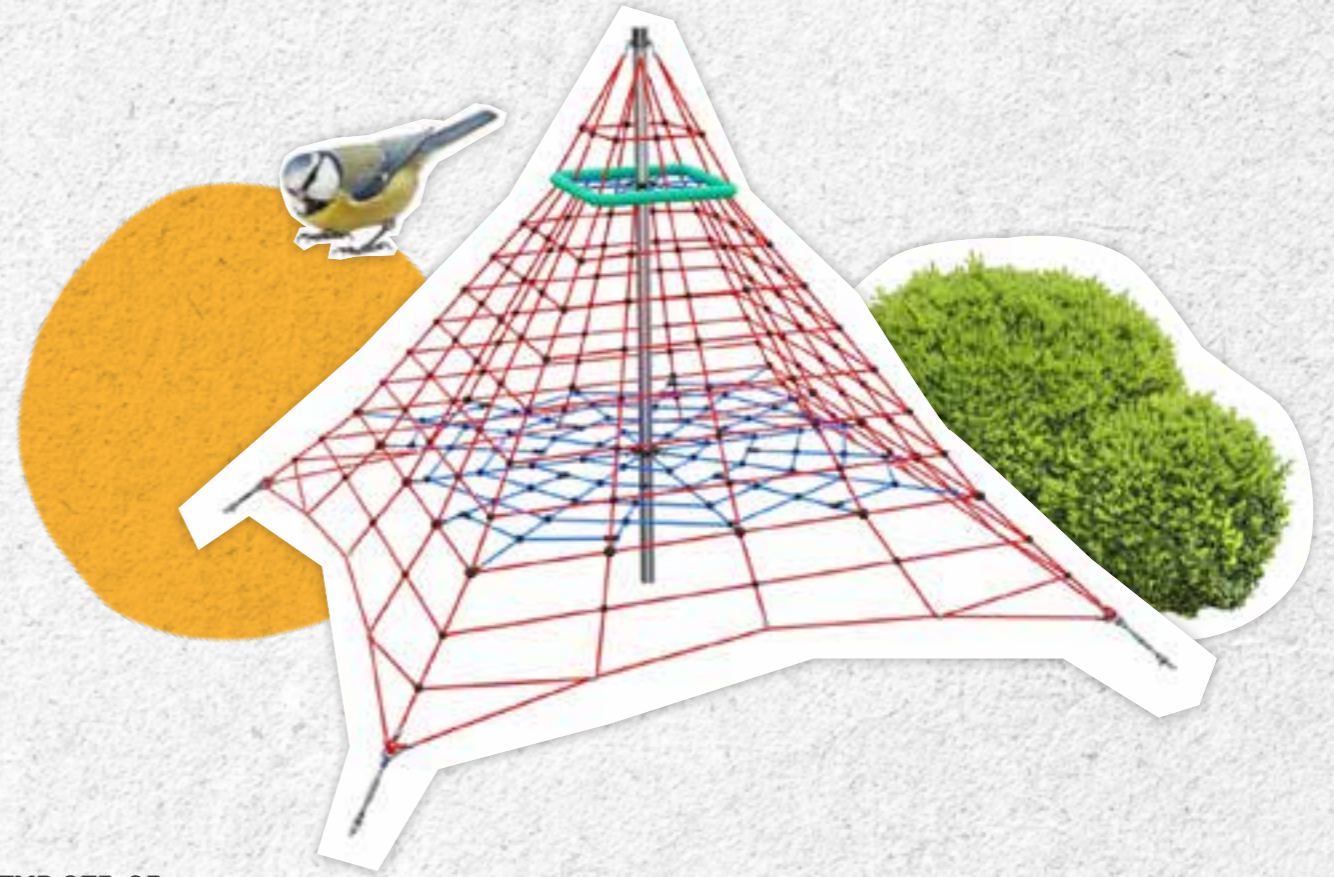

TYP 350-95 TETRA
ART. 01003509



TYP 375-95
ART. 010045092

	Herkules (16 mm), 6-schäftig, PES mit Stahlseele 6-strand, PES with steel core
	88,9 x 4 x 4350 mm Stahlrohr, feuerverzinkt Steel pipe, hot-dip galvanised
	3,50 m
	4,00 x 3,46 m
	0,95 m
	Wantenspanner M 16, feuerverzinkt M 16 turnbuckles, hot-dip galvanised
	3-10 Jahre / Years 17 Benutzer / User
	min. 2,60 x 7,00 m max. 7,00 x 7,00 m
	Netz (Net): 60 kg, 80 x 60 x 70 cm Pfosten (Post): 35 kg, 435 x 10 x 10 cm

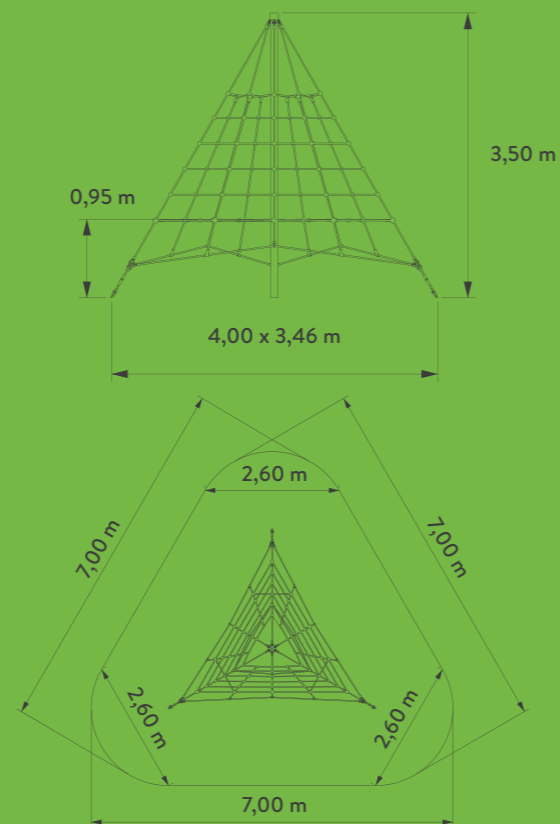

	Herkules (16 mm), 6-schäftig, PES mit Stahlseele 6-strand, PES with steel core
	88,9 x 4 x 4600 mm Stahlrohr, feuerverzinkt Steel pipe, hot-dip galvanised
	3,75 m
	5,10 x 5,10 m
	0,95 m
	Wantenspanner M 20, feuerverzinkt M 20 turnbuckles, hot-dip galvanised
	4-14 Jahre / Years 35 Benutzer / User
	7,40 x 7,40 m
	Netz (Net): 100 kg, 120 x 80 x 110 cm Pfosten (Post): 37 kg, 460 x 10 x 10 cm

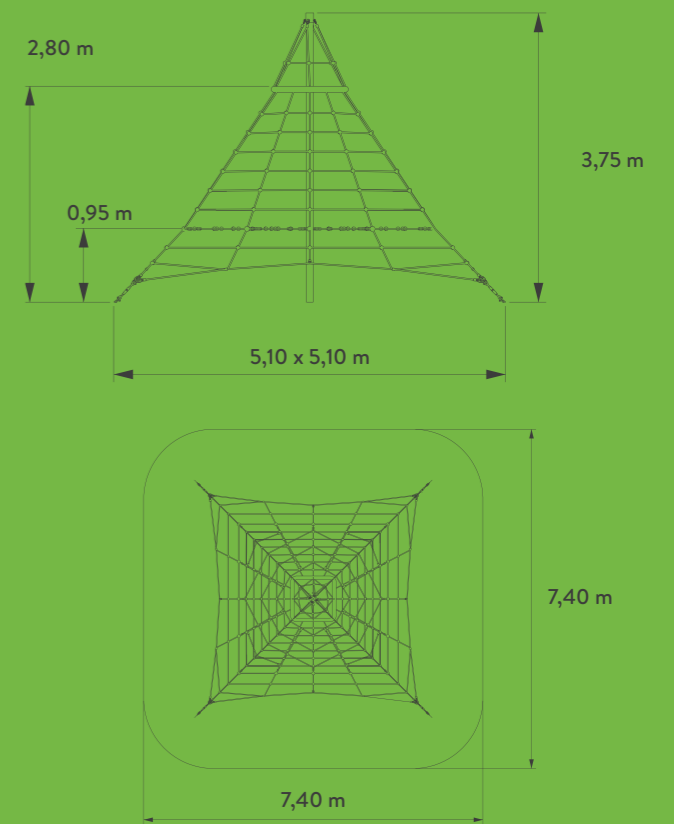

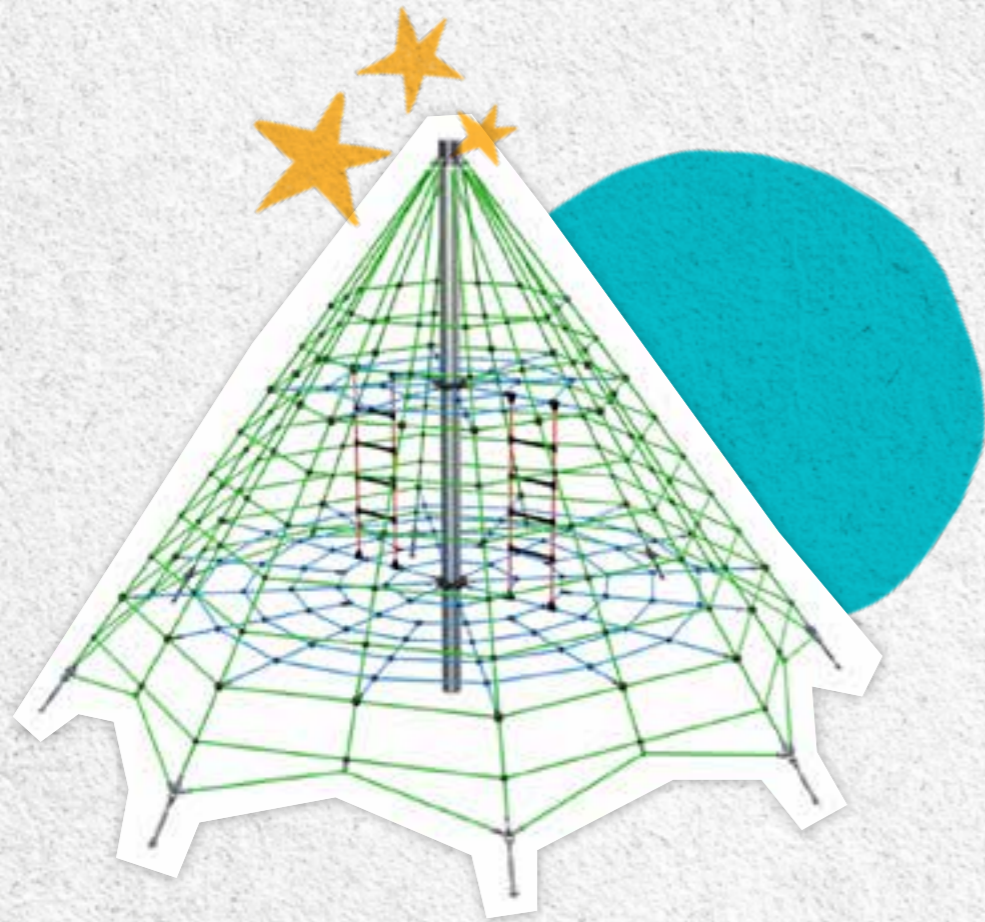

TYP 450-95
ART. 01004509

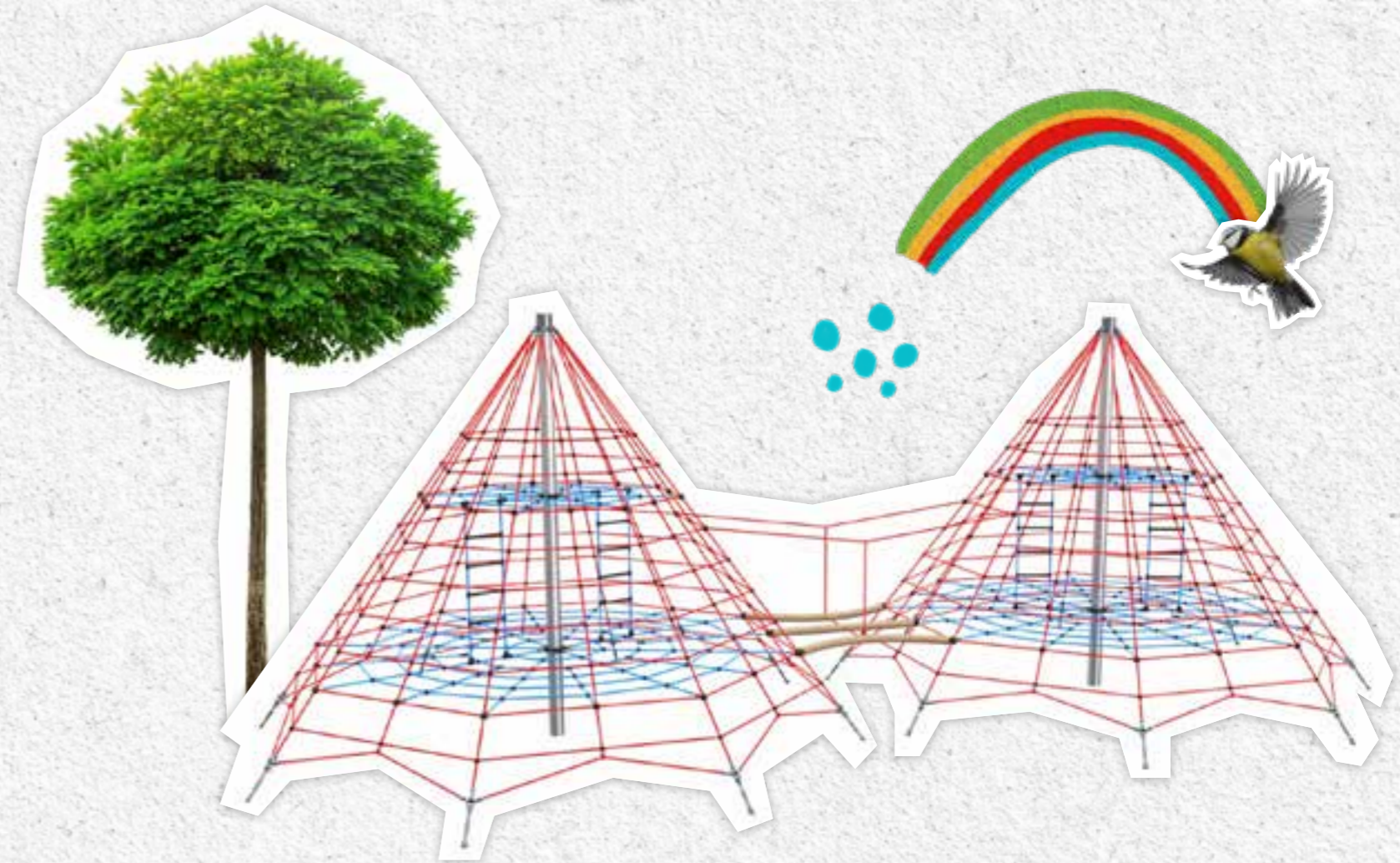

TYP 450-95 DUO
ART. 010045092

	Herkules (16 mm), 6-schäftig, PES mit Stahlseele 6-strand, PES with steel core
	152,4 x 4,5 x 5350 mm Stahlrohr, feuerverzinkt Steel pipe, hot-dip galvanized
	4,50 m Ø 6,70 m
	0,95 m
	Wantenspanner M 16, feuerverzinkt M 16 turnbuckles, hot-dip galvanized
	4-14 Jahre / Years 48 Benutzer / User
	8,75 m
	Netz (Net): 180 kg, 120 x 80 x 110 cm Pfosten (Post): 91 kg, 535 x 30 x 30 cm

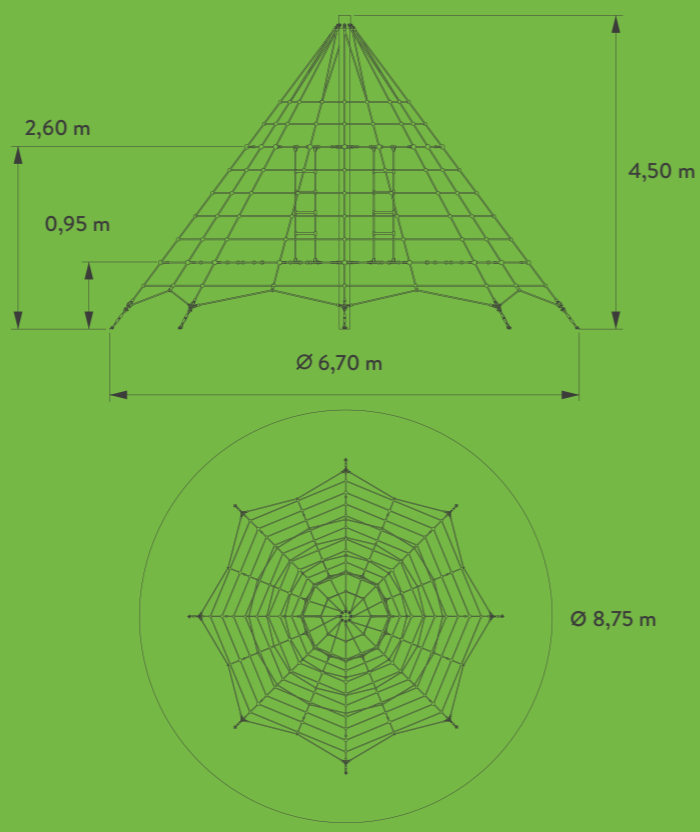

	Herkules (16 mm), 6-schäftig, PES mit Stahlseele 6-strand, PES with steel core
	152,4 x 4,5 x 5350 mm Stahlrohr, feuerverzinkt Steel pipe, hot-dip galvanized
	4,50 m Ø 12,85 x 6,70 m
	0,95 m
	Wantenspanner M 16, feuerverzinkt M 16 turnbuckles, hot-dip galvanized
	4-14 Jahre / Years 100 Benutzer / User
	15,40 x 8,75 m
	Netz (Net): 400 kg, 2 PCS 120 x 80 x 110 cm Pfosten (Post): 182 kg, 2 PCS 535 x 30 x 30 cm

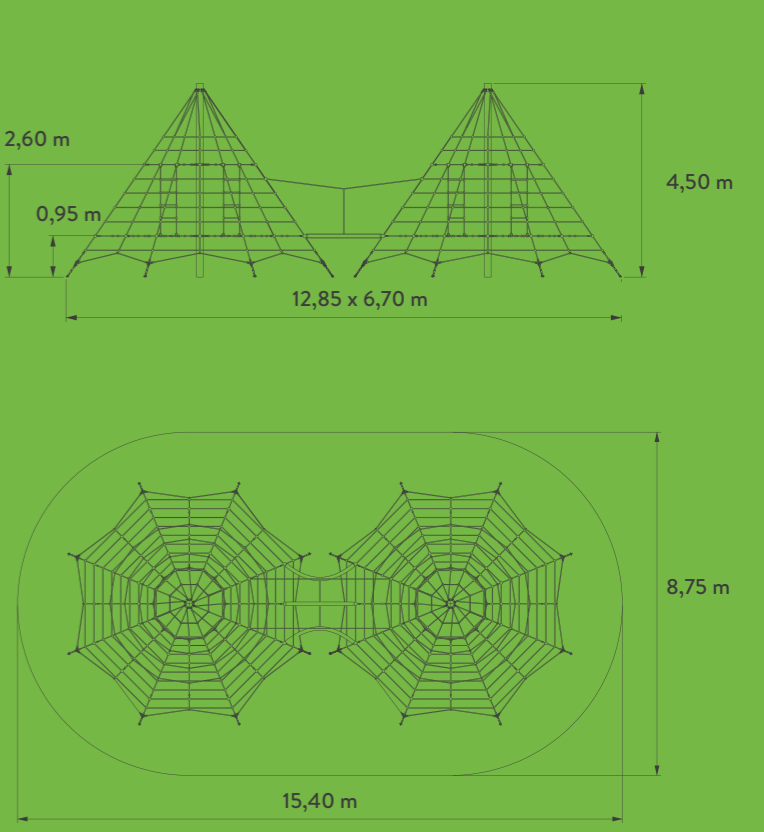

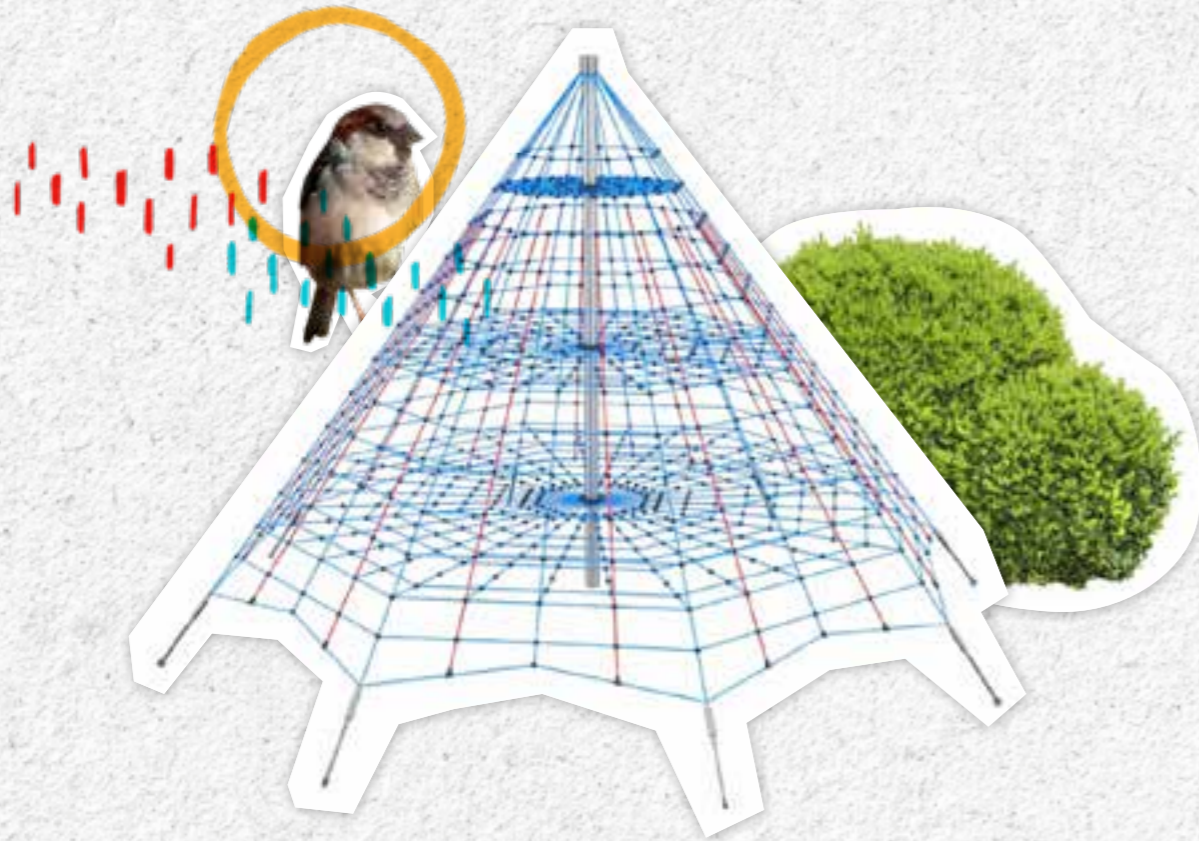



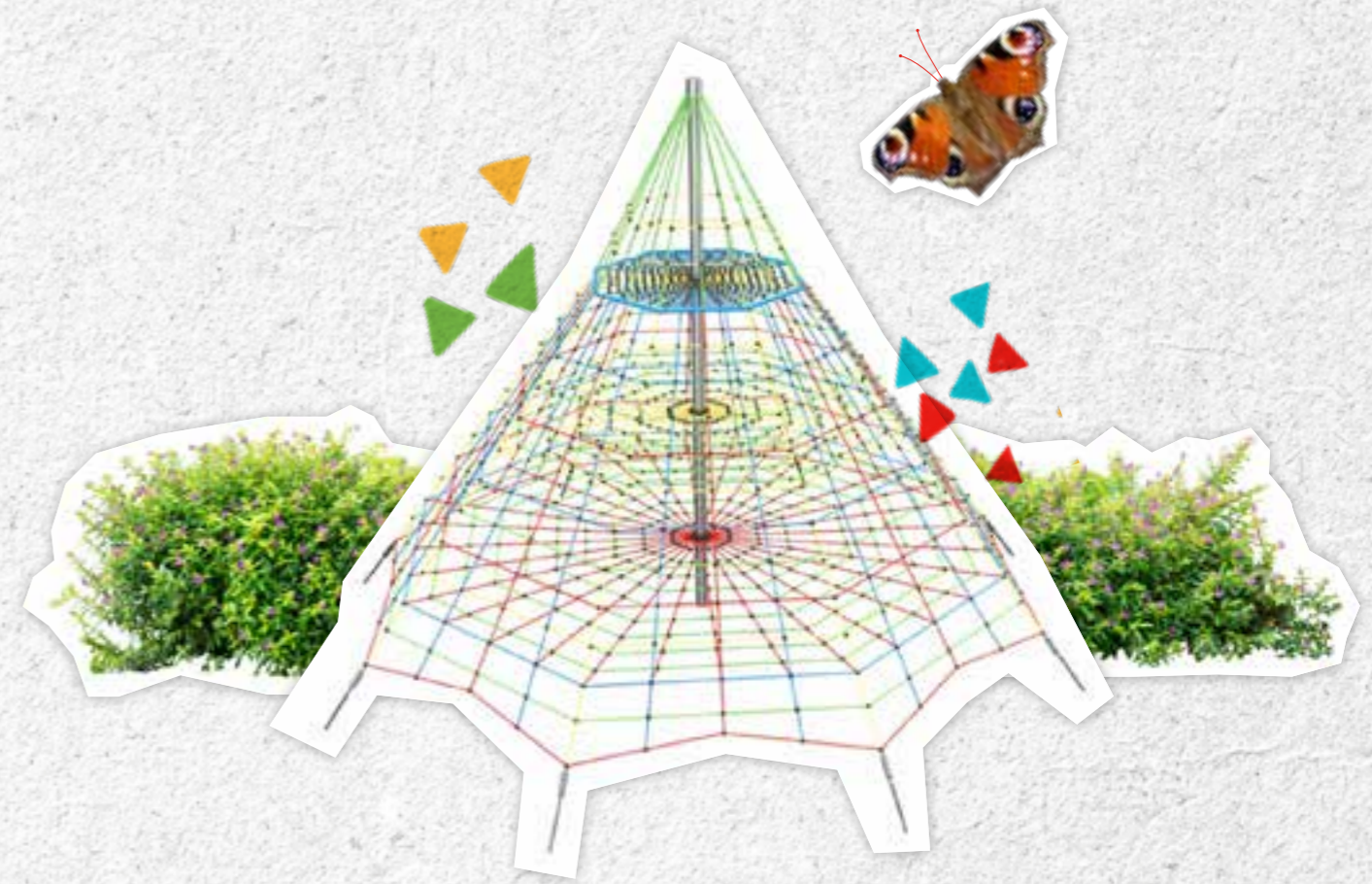



TYP 550-95
ART. 01005509



TYP 650-95
ART. 01006509

	Herkules (16 mm), 6-schäftig, PES mit Stahlseele 6-strand, PES with steel core
	152,4 x 4,5 x 6350 mm Stahlrohr, feuerverzinkt Steel pipe, hot-dip galvanised
	5,50 m Ø 8,30 m
	0,95 m
	Wantenspanner M 20, feuerverzinkt M 20 turnbuckles, hot-dip galvanised
	6-14 Jahre / Years 79 Benutzer / User
	10,40 m
	Netz (Net): 230 kg, 120 x 80 x 110 cm Pfosten (Post): 108 kg, 635 x 30 x 30 cm

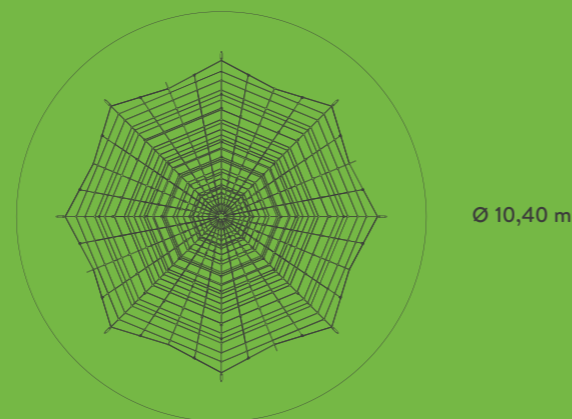
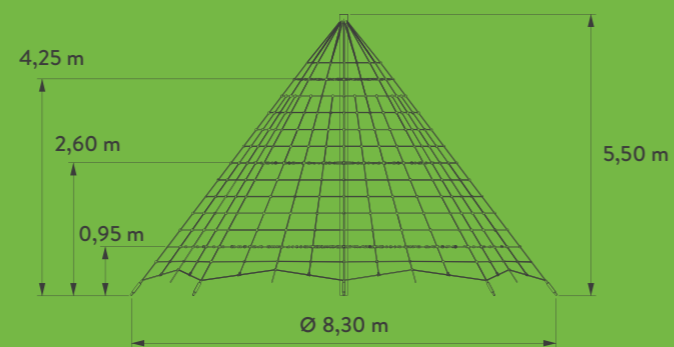



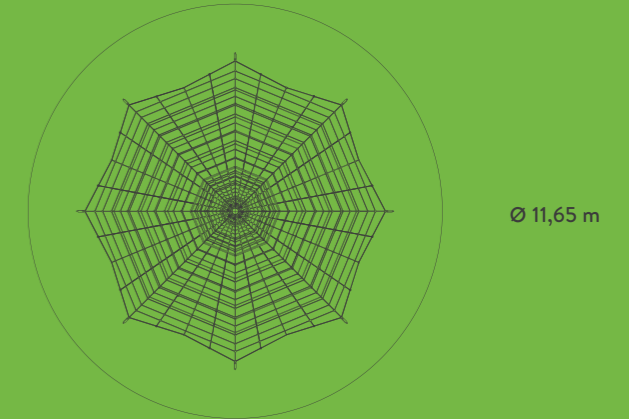
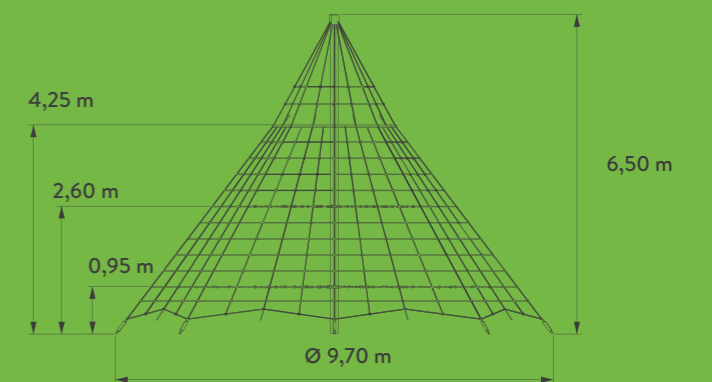

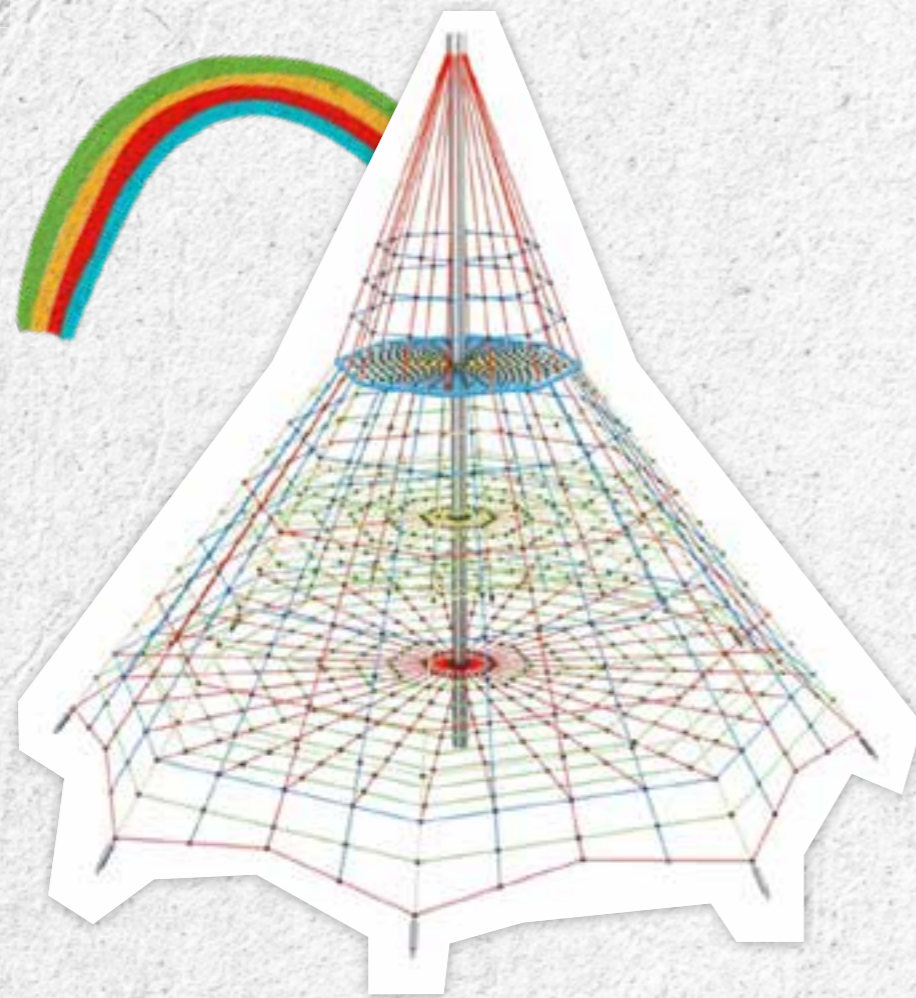



	Herkules (16 mm), 6-schäftig, PES mit Stahlseele 6-strand, PES with steel core
	152,4 x 4,5 x 7350 mm Stahlrohr, feuerverzinkt Steel pipe, hot-dip galvanised
	6,50 m Ø 9,70 m
	0,95 m
	Wantenspanner M 20, feuerverzinkt M 20 turnbuckles, hot-dip galvanised
	6-14 Jahre / Years 98 Benutzer / User
	11,65 m
	Netz (Net): 380 kg, 220 x 220 x 170 cm Pfosten (Post): 125 kg, 735 x 30 x 30 cm





TYP 750-95
ART. 01007509



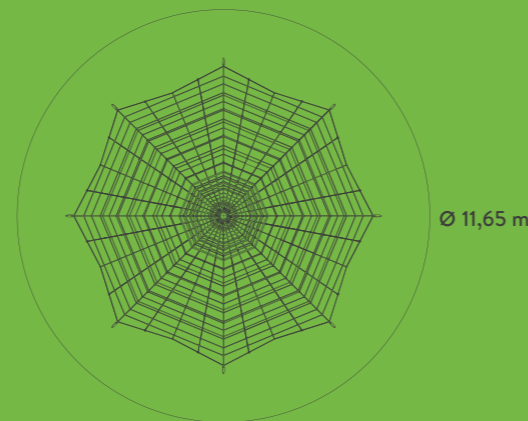
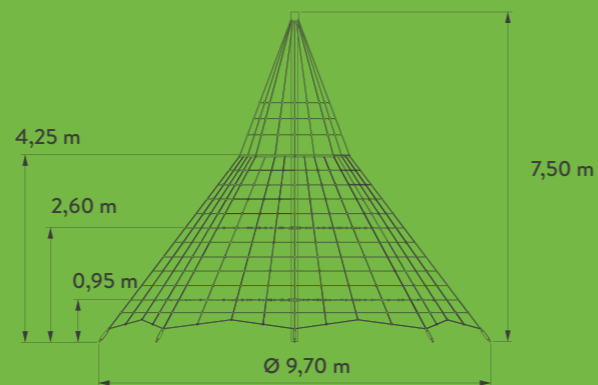

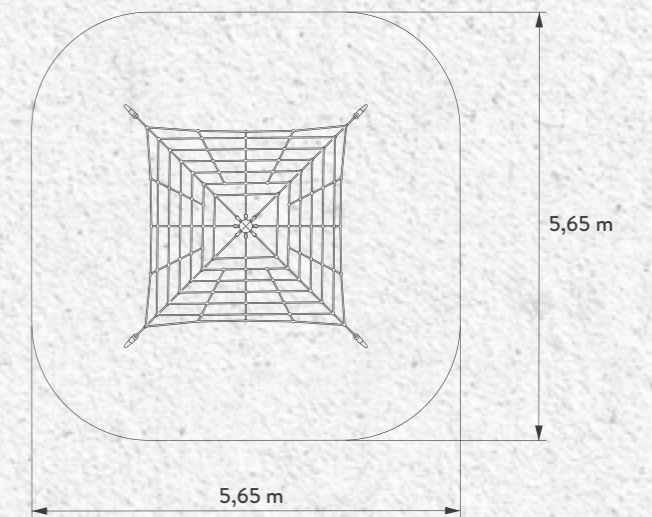
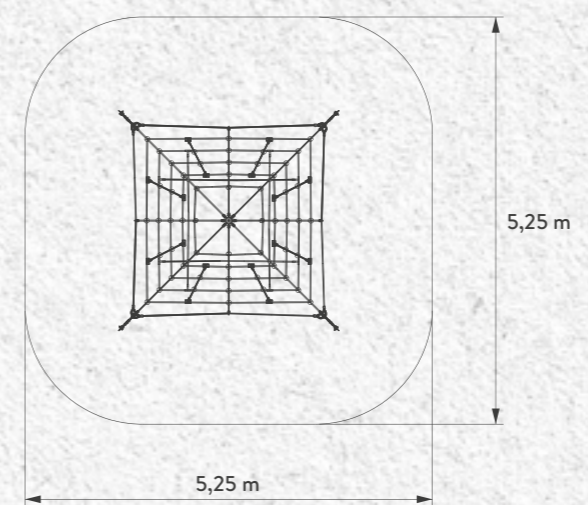
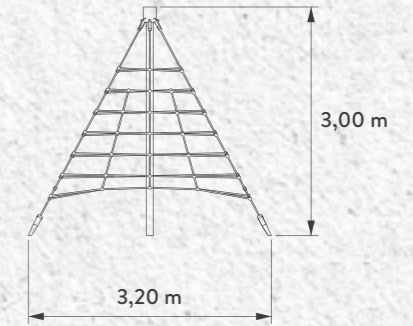
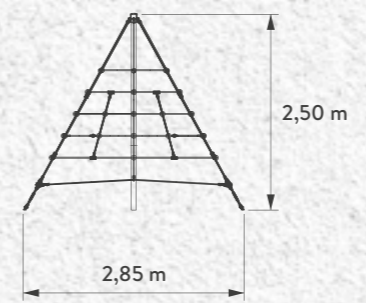













	Herkules (16 mm), 6-schäftig, PES mit Stahlseele 6-strand, PES with steel core
	152,4 x 4,5 x 8350 mm Stahlrohr, feuerverzinkt Steel pipe, hot-dip galvanized
	7,50 m
	Ø 9,70 m
	0,95 m
	Wantenspanner M 20, feuerverzinkt M 20 turnbuckles, hot-dip galvanized
	6-14 Jahre / Years 98 Benutzer / User
	11,65 m
	Netz (Net): 400 kg, 220 x 220 x 170 cm Pfosten (Post): 142 kg, 835 x 30 x 30 cm





TYP 250
ART. 0100250

TYP 300
ART. 0100300

	Herkules (16 mm), 6-schäftig, PES mit Stahlseele 6-strand, PES with steel core		Herkules (16 mm), 6-schäftig, PES mit Stahlseele 6-strand, PES with steel core
	88,9 x 4 x 3350 mm Stahlrohr, feuerverzinkt Steel pipe, hot-dip galvanised		88,9 x 4 x 3850 mm Stahlrohr, feuerverzinkt Steel pipe, hot-dip galvanised
	2,50 m		3,00 m
	2,85 x 2,85 m		3,20 x 3,20 m
	0,95 m		2,35 m
	Wantenspanner M 16, feuerverzinkt M 16 turnbuckles, hot-dip galvanised		Wantenspanner M 16, feuerverzinkt M 16 turnbuckles, hot-dip galvanised
	3-10 Jahre / Years 14 Benutzer / User		3-10 Jahre / Years 14 Benutzer / User
	5,25 x 5,25 m		5,65 x 5,65 m
	Netz (Net): 50 kg, 80 x 60 x 60 cm Pfosten (Post): 25 kg, 335 x 10 x 10 cm		Netz (Net): 55 kg, 80 x 60 x 70 cm Pfosten (Post): 30 kg, 385 x 10 x 10 cm

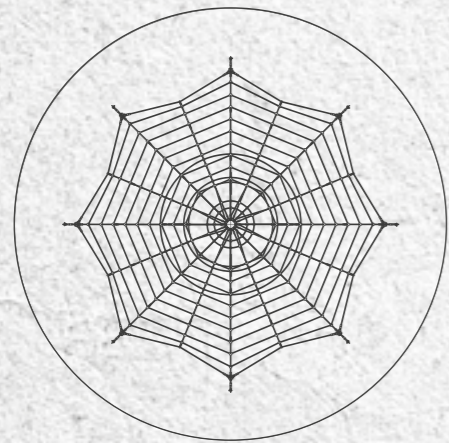
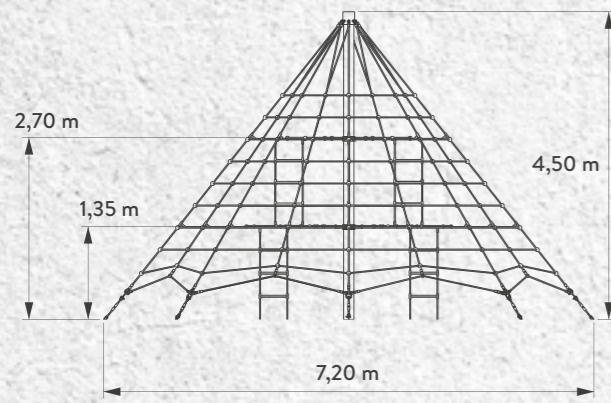

Ø 9,25 m

TYP 450
ART. 0100450

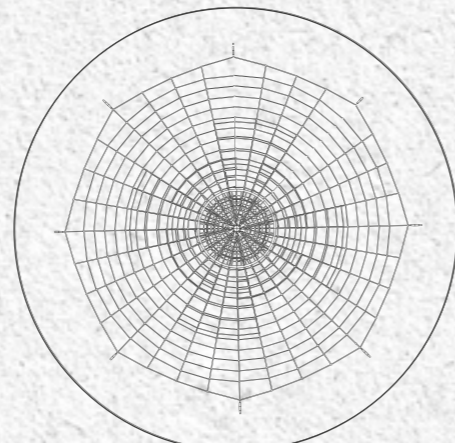
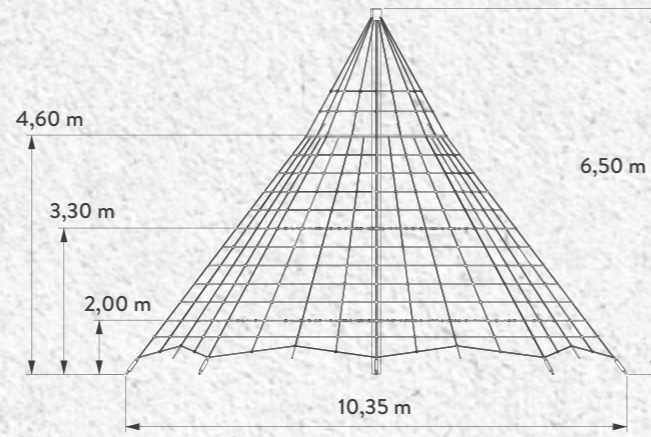

Ø 12,35 m

TYP 650
ART. 0100650

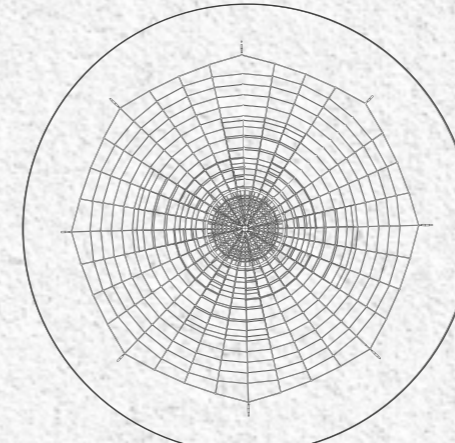
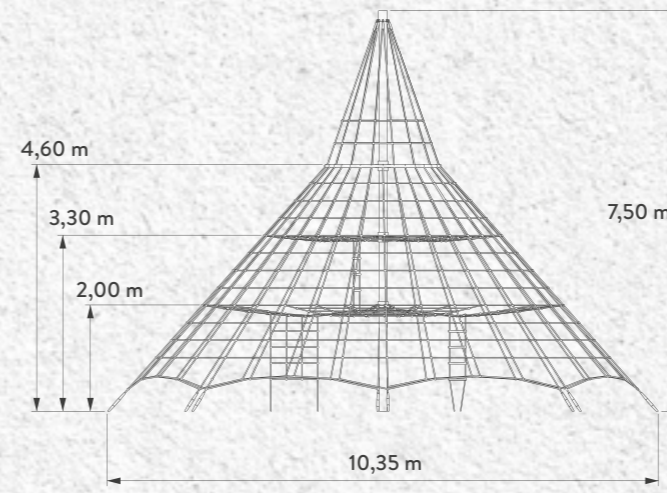

Ø 12,35 m

TYP 750
ART. 0100750



	Herkules (16 mm), 6-schäftig, PES mit Stahlseele 6-strand, PES with steel core
	152,4 x 4,5 x 5350 mm Stahlrohr, feuerverzinkt Steel pipe, hot-dip galvanised
	4,50 m
	7,20 m
	1,35 m
	Wantenspanner M 16, feuerverzinkt M 16 turnbuckles, hot-dip galvanised
	4-14 Jahre / Years 48 Benutzer / User
	9,25 m
	Netz (Net): 180 kg, 120 x 80 x 110 cm Pfosten (Post): 91 kg, 535 x 30 x 30 cm

	Herkules (16 mm), 6-schäftig, PES mit Stahlseele 6-strand, PES with steel core
	152,4 x 4,5 x 7350 mm Stahlrohr, feuerverzinkt Steel pipe, hot-dip galvanised
	6,50 m
	10,35 m
	2,00 m
	Wantenspanner M 20, feuerverzinkt M 20 turnbuckles, hot-dip galvanised
	6-14 Jahre / Years 98 Benutzer / User
	12,35 m
	Netz (Net): 380 kg, 220 x 220 x 170 cm Pfosten (Post): 125 kg, 735 x 30 x 30 cm

	Herkules (16 mm), 6-schäftig, PES mit Stahlseele 6-strand, PES with steel core
	152,4 x 4,5 x 8350 mm Stahlrohr, feuerverzinkt Steel pipe, hot-dip galvanised
	7,50 m
	10,35 m
	2,00 m
	Wantenspanner M 20, feuerverzinkt M 20 turnbuckles, hot-dip galvanised
	6-14 Jahre / Years 98 Benutzer / User
	12,35 m
	Netz (Net): 400 kg, 220 x 220 x 170 cm Pfosten (Post): 142 kg, 835 x 30 x 30 cm

SCHAUKELN

SWINGS

ALLEINE ODER GEMEINSAM MIT FREUNDEN – SCHAUKELN MACHT GLÜCKLICH!

Die Bewegung unterstützt die Entwicklung des Gleichgewichtssinnes und löst ein herrliches Kribbeln im Bauch aus. Rundum dick gepolstert, laden unsere Schaukeln zum Träumen oder Schaukel-Abenteuer ein. Dabei sorgt unser Wohlfühl-Netz aus Usacord Longlife-Seilen für einen wohligen Liegekomfort und bietet einen ausgezeichneten Schutz vor Vandalismus. Aber auch in puncto Sicherheit überzeugen die original Nestschaukeln von Ullmann – Sicherheitsaufhängungen sowie die in unserem Haus entwickelten »Usacord-Safety-Schäkel« machen sie besonders sicher. Unsere Schaukeln können auch nach Ihren Vorgaben und Wünschen in riesiger Farbvielfalt gefertigt werden.

FÜR SICHEREN SCHAUKEL-SPASS:

- Hoher Liege- und Schaukelkomfort durch unsere Usacord Longlife-Seile
- Vandalismussicher durch Usacord Longlife- und Herkules-Seile
- Rundum gepolsterte Schaukelringe für höchste Sicherheit
- Sicherer Halt auch für kleine Kinder durch Netzstruktur
- Klemmschutz durch Usacord-Safety-Schäkel
- 360 verschiedene Farbkombinationen ohne Aufpreis lieferbar
- Aufhängungen individuell nach Kundenvorgaben
- Kurze Lieferzeiten

WHETHER ALONE OR TOGETHER WITH FRIENDS - SWINGING MAKES YOU HAPPY!

The movement supports the development of the sense of balance and triggers a wonderful tingling in the stomach. Thickly padded all around, our swings invite you to dream or to have a swinging adventure. At the same time, our feel-good net made of Usacord Longlife ropes ensures cosy reclining comfort and offers excellent protection against vandalism. The original nest swings from Ullmann are also convincing in terms of safety - safety suspensions as well as the "Usacord Safety Shackles", developed in our company, make them particularly safe. Our swings can also be manufactured according to your specifications and wishes, in a huge variety of colours.

FOR SAFE SWINGING FUN:

- High lying and swinging comfort due to our Usacord Longlife ropes.
- Vandalism-proof due to Usacord Longlife and Herkules ropes
- Swing rings padded all round for maximum safety
- Secure hold even for small children due to net structure
- Pinch protection due to Usacord safety shackles
- 360 different colour combinations available at no extra charge
- Suspensions individually according to customer specifications
- Short delivery times



**WIR BRINGEN FARBE
INS SPIEL!**

**WE BRING COLOUR INTO
THE GAME!**



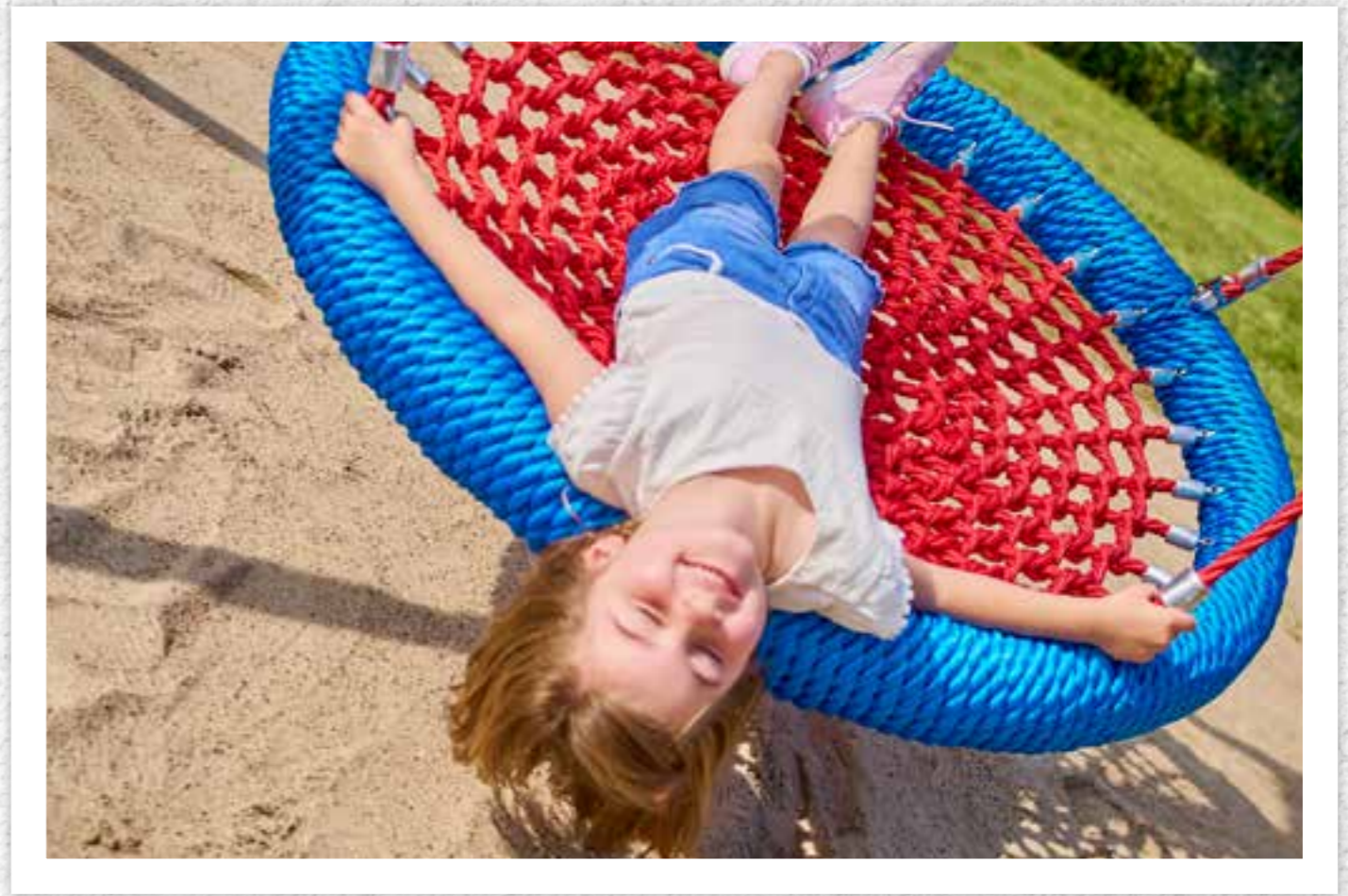
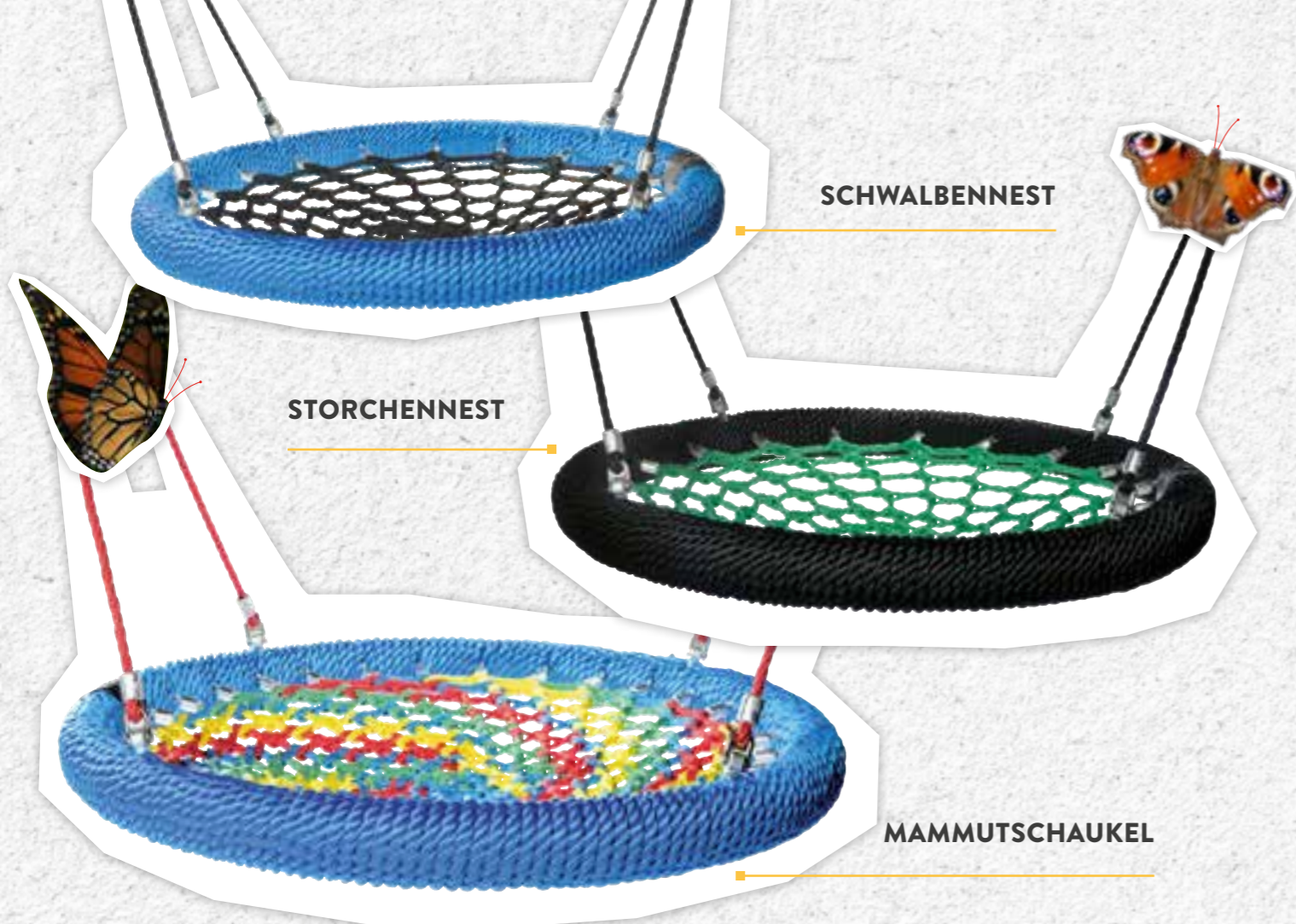

SCHWALBENNEST | SWALLOW NEST
ART. 011002

STORCHENNEST | STORK NEST
ART. 011202

MAMMUTSCHAUKEL | MAMMUT SWING
ART. 011452

	Usacord Longlife (16 mm), 4-schäftig, PES mit Stahlseele 4-strand, PES with steel core
	Stahl feuerverzinkt / steel, hot-dip galvanised Ø 1,00 m
	3,00 m
	Herkules 16 mm, 4-schäftig, PES mit Stahlseele, Länge nach Maß passend zur Aufhängehöhe Herkules 16 mm, 4 strand, PES with steel core, length according to suspension height
	Edelstahl V2A V2A stainless steel
	30 kg, 100 x 100 x 12 cm 15 PCS/Packing Unit, 450 kg, 100 x 100 x 200 cm

	Usacord Longlife (16 mm), 4-schäftig, PES mit Stahlseele 4-strand, PES with steel core
	Stahl feuerverzinkt / steel, hot-dip galvanised Ø 1,20 m
	3,00 m
	Herkules 16 mm, 4-schäftig, PES mit Stahlseele, Länge nach Maß passend zur Aufhängehöhe Herkules 16 mm, 4 strand, PES with steel core, length according to suspension height
	Edelstahl V2A V2A stainless steel
	33 kg, 120 x 120 x 12 cm 15 PCS/Packing Unit, 495 kg, 120 x 120 x 200 cm

	Usacord Longlife (16 mm), 4-schäftig, PES mit Stahlseele 4-strand, PES with steel core
	Stahl feuerverzinkt / steel, hot-dip galvanised Ø 1,45 m
	3,00 m
	Herkules 16 mm, 4-schäftig, PES mit Stahlseele, Länge nach Maß passend zur Aufhängehöhe Herkules 16 mm, 4 strand, PES with steel core, length according to suspension height
	Edelstahl V2A V2A stainless steel
	43 kg, 145 x 145 x 12 cm 15 PCS/Packing Unit, 645 kg, 145 x 145 x 200 cm

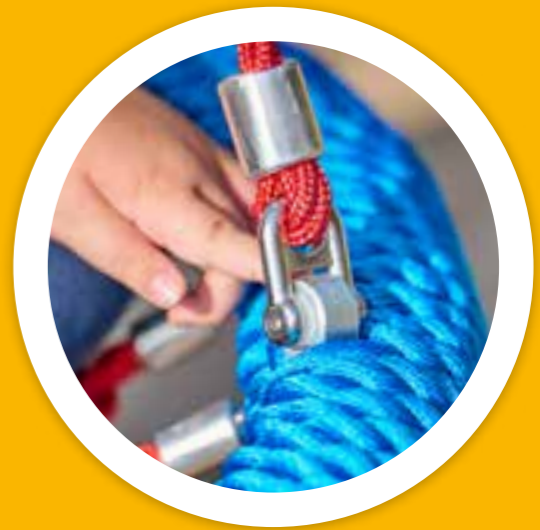

SICHERHEITS-SCHÄKEL
SAFETY SHACKLE



SPATZENNEST | SPARROW NEST
ART. 0110036 – FEINMASCHIG | FINE MESH

KÜKENNEST | CHICK NEST
ART. 0112036 – FEINMASCHIG | FINE MESH



AUFHÄNGEZUBEHÖR EDELSTAHL
STAINLESS STEEL SUSPENSION



Usacord Longlife (16 mm),
4-schäftig, PES mit Stahlseele
4-strand, PES with steel core



Stahl feuerverzinkt / steel, hot-dip galvanised
Ø 1,00 m



3,00 m
MAX



Herkules 16 mm, 4-schäftig, PES mit Stahlseele,
Länge nach Maß passend zur Aufhängehöhe
Herkules 16 mm, 4 strand, PES with steel core,
length according to suspension height



Edelstahl V2A
V2A stainless steel



32 kg, 100 x 100 x 12 cm
15 PCS/Packing Unit, 480 kg,
100 x 100 x 200 cm



Usacord Longlife (16 mm),
4-schäftig, PES mit Stahlseele
4-strand, PES with steel core



Stahl feuerverzinkt / steel, hot-dip galvanised
Ø 1,20 m



3,00 m
MAX



Herkules 16 mm, 4-schäftig, PES mit Stahlseele,
Länge nach Maß passend zur Aufhängehöhe
Herkules 16 mm, 4 strand, PES with steel core,
length according to suspension height



Edelstahl V2A
V2A stainless steel



37 kg, 120 x 120 x 12 cm
15 PCS/Packing Unit, 555 kg,
120 x 120 x 200 cm



- Kreuzgelenk für runde Kopfbalken, komplett mit Sicherungskette 7 mm
- Universal joint, complete with safety-bolt and chain 7 mm

ART. 85599



- Kreuzgelenk für eckige Kopfbalken, komplett mit Sicherungskette 7 mm
- Universal joint for square beams, complete with safety-chain 7 mm

ART. 85595



- Kardangelen für horizontale Kopfbalken, 1-Punktaufhängung, komplett mit Sicherungskette 7 mm
- Cardan joint for horizontal beams, 1-point suspension, complete with safety-chain 7 mm

ART. 85511

OHNE ABBILDUNG

WITHOUT
ILLUSTRATION

- Kardangelen für schräge Kopfbalken, 1-Punktaufhängung, komplett mit Sicherungskette 7 mm
- Cardan joint for sloping beams, 1-point suspension, complete with safety-chain 7 mm

ART. 85510

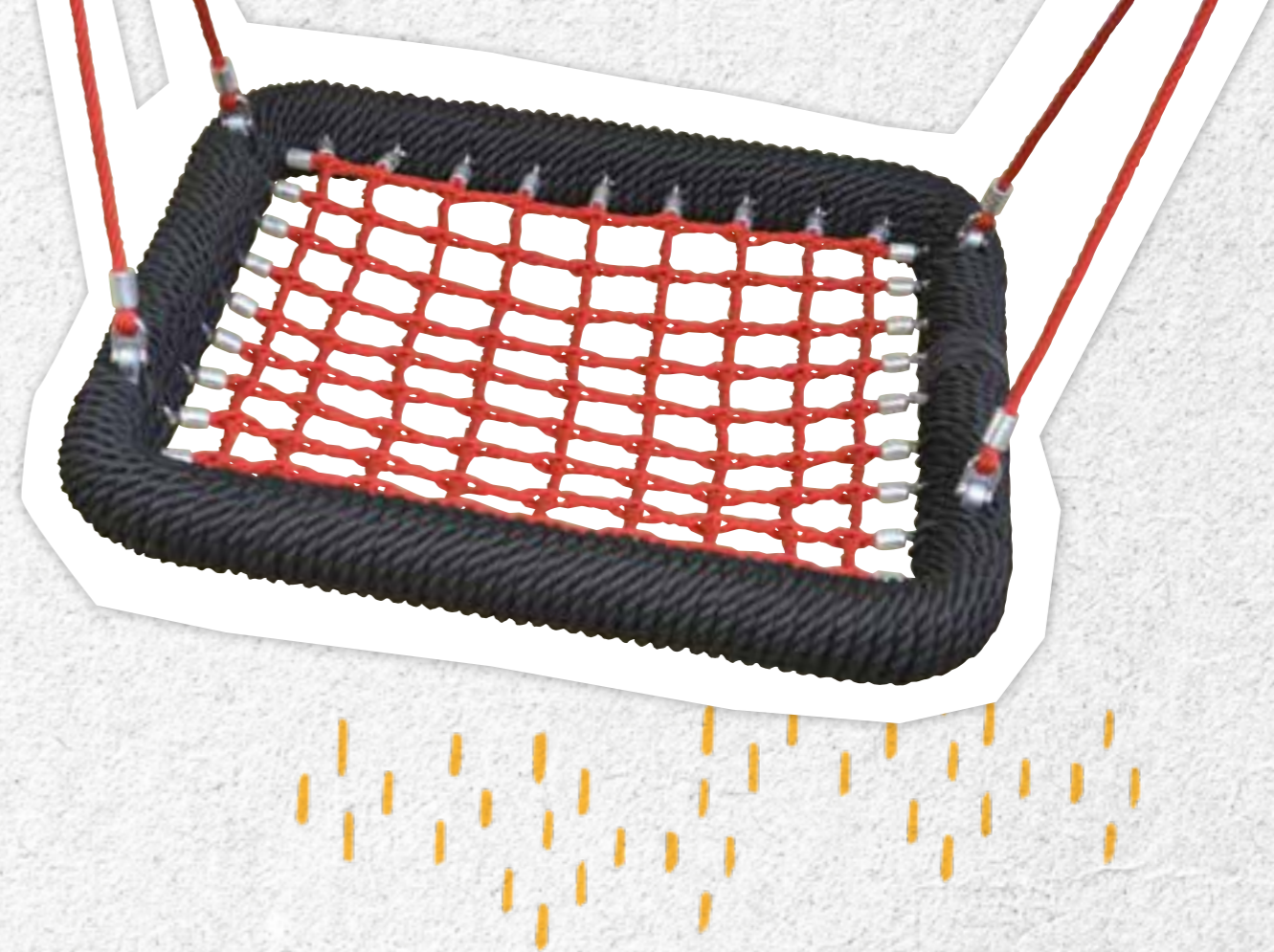

NESTSCHAUKEL | NET SWING
ABSORBER STAR 50 G
 ART. 011205

AUFHÄNGEVARIANTEN NESTSCHAUKELN
 SUSPENSION OPTIONS FOR NEST SWINGS

QUADRA 50 G, 90 CM
 ART. 010902

QUADRA, 110 CM
 ART. 0101202

	Usacord Longlife (16 mm), 4-schäftig, PES mit Stahlseele 4-strand, PES with steel core
	Kunststoff, verschweißt / Plastic, welded Ø 1,20 m
	3,00 m
	Herkules 16 mm, 4-schäftig, PES mit Stahlseele, Länge nach Maß passend zur Aufhängehöhe Herkules 16 mm, 4 strand, PES with steel core, length according to suspension height
	Edelstahl V2A V2A stainless steel
	35 kg, 120 x 120 x 20 cm 15 PCS/Packing Unit, 525 kg, 120 x 120 x 200 cm

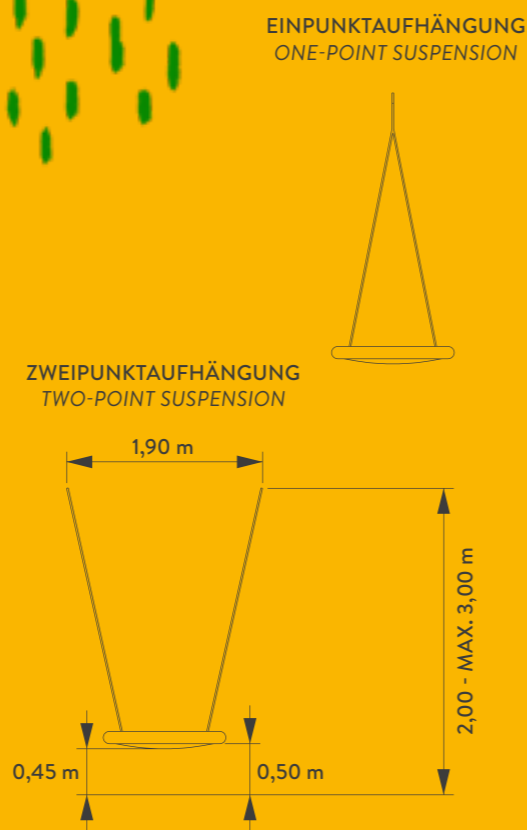

	Usacord Longlife (16 mm), 4-schäftig, PES mit Stahlseele 4-strand, PES with steel core
	Stahl feuerverzinkt - steel, hot-dip galvanised 0,90 x 0,90 m
	3,00 m
	Herkules 16 mm, 4-schäftig, PES mit Stahlseele, Länge nach Maß passend zur Aufhängehöhe Herkules 16 mm, 4 strand, PES with steel core, length according to suspension height
	Edelstahl V2A V2A stainless steel
	33 kg, 90 x 90 x 12 cm 15 PCS/Packing Unit, 495 kg, 90 x 90 x 200 cm

	Usacord Longlife (16mm), 4-schäftig, PES mit Stahlseele 4-strand, PES with steel core
	Stahl feuerverzinkt - steel, hot-dip galvanised 1,10 x 1,10 m
	3,00 m
	Herkules 16 mm, 4-schäftig, PES mit Stahlseele, Länge nach Maß passend zur Aufhängehöhe Herkules 16 mm, 4 strand, PES with steel core, length according to suspension height
	Edelstahl V2A V2A stainless steel
	36 kg, 120 x 120 x 12 cm 15 PCS/Packing Unit, 540 kg, 120 x 120 x 200 cm



AUCH ERHÄLTlich
MIT SICHERUNGSSEIL
ALSO AVAILABLE WITH
SAFETY ROPE

SITZSCHAUKEL HOLLYWOOD UNO
SWING SEAT HOLLYWOOD UNO
ART. 010912



SITZSCHAUKEL HOLLYWOOD DUO
SWING SEAT HOLLYWOOD DUO
ART. 011250



Usacord Longlife (16 mm),
4-schäftig, PES mit Stahlseele
4-strand, PES with steel core



0,88 x 0,70 x 1,17 m



3,00 m



Herkules 16 mm, 4-schäftig, PES mit Stahlseele,
Länge nach Maß passend zur Aufhängehöhe
Herkules 16 mm, 4 strand, PES with steel core,
length according to suspension height



Edelstahl V2A
V2A stainless steel



50 kg, 125 x 85 x 50 cm
10 PCS/Packing Unit,
500 kg, 125 x 80 x 180 cm

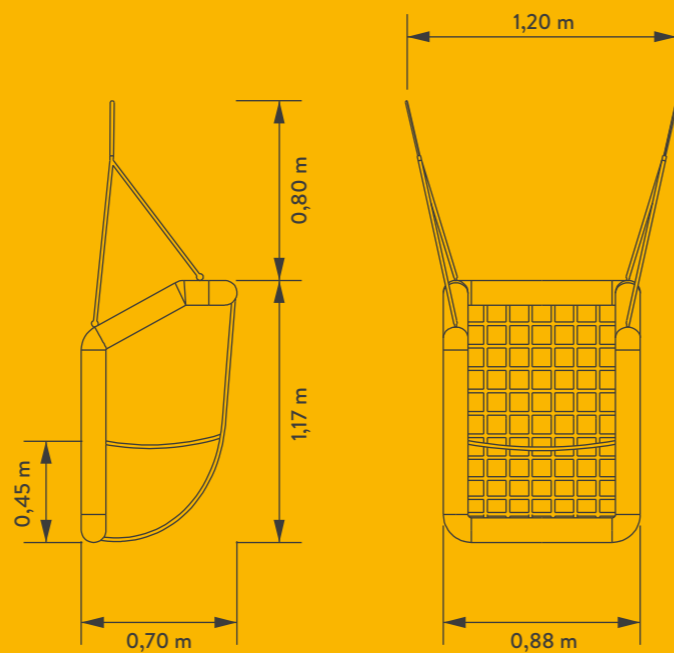

Usacord Longlife (16 mm),
4-schäftig, PES mit Stahlseele
4-strand, PES with steel core



1,29 x 0,70 x 1,17 m



3,00 m



Herkules 16 mm, 4-schäftig, PES mit Stahlseele,
Länge nach Maß passend zur Aufhängehöhe
Herkules 16 mm, 4 strand, PES with steel core,
length according to suspension height



Edelstahl V2A
V2A stainless steel



70 kg, 130 x 120 x 50 cm
10 PCS/Packing Unit,
700 kg, 130 x 120 x 185 cm

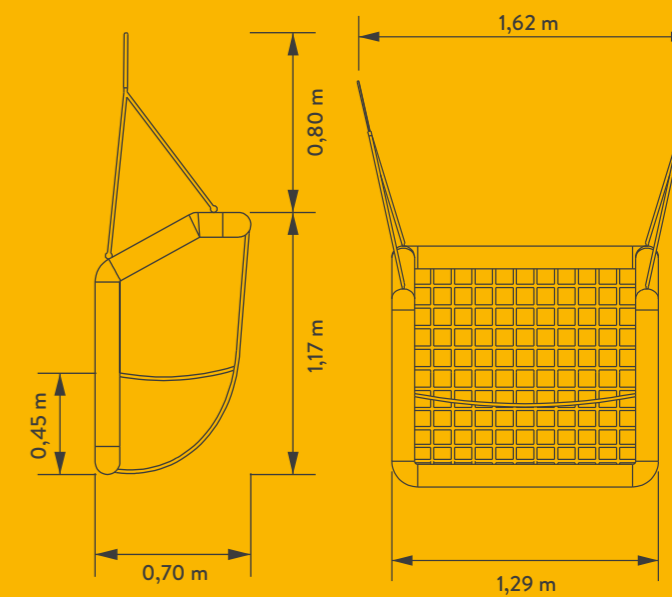



MINI-NEST-SET SCHWALBENNEST
 MINI NEST SET SWALLOW NEST
 ART. 011002226

MINI-NEST-SET SPATZENEST
 MINI NEST SET SPARROW NEST
 ART. 01100236226 FEINMASCHIG | FINE MESH







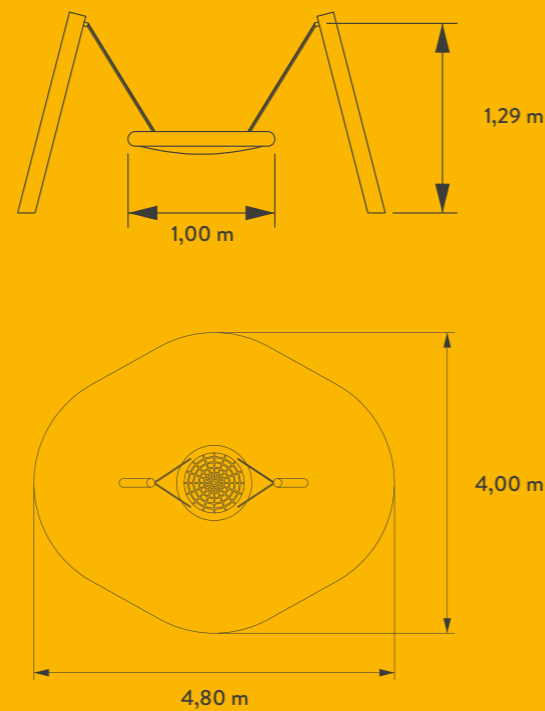

MINI-TAMPEN-SET
 MINI ROPE SET
 ART. 011080226

MINI-KLEINKINDERSITZ-SET
 MINI TODDLER SEAT SET
 ART. 0111264226

-  Usacord Longlife (16 mm), 4-schäftig, PES mit Stahlseele
4-strand, PES with steel core
-  Stahlrohr, feuerverzinkt
Steel pipe, hot-dip galvanised
Ø 1,00 m
-  114,3 x 4 x 2260 mm
Stahlrohr, feuerverzinkt, pulverbeschichtet
Steel pipe, hot-dip galvanise, powder-coated
-  1,29 m über Spielebene
Above play area
-  Herkules 16 mm, 4-schäftig, PES mit Stahlseele
Herkules 16 mm, 4 strand, PES with steel core
-  Edelstahl V2A
V2A stainless steel
-  4,80 x 4,00 m
-  110 kg, 230 x 100 x 30 cm
5 PCS/Packing Unit, 550 kg, 230 x 100 x 160 cm



-  Fendex-Tauwerk 140 mm Quadrat
Fendex-rope 140 mm, Square
-  114,3 x 2260 mm
Stahlrohr, feuerverzinkt, pulverbeschichtet
Steel pipe, hot-dip galvanise, powder-coated
-  1,29 m über Spielebene
Above play area
-  Herkules 16 mm, 4-schäftig, PES mit Stahlseele
Herkules 16 mm, 4-strand, PES with steel core
-  Edelstahl V2A
V2A stainless steel
-  2,50 x 4,00 m
-  110 kg, 230 x 100 x 30 cm
5 PCS/Packing Unit, 550 kg, 230 x 100 x 160 cm

-  114,3 x 4 x 2260 mm Stahlrohr,
feuerverzinkt, pulverbeschichtet
Steel pipe, hot-dip galvanised, powder-coated
-  1,29 m über Spielebene
Above play area
-  Herkules 16 mm, 4-schäftig,
PES mit Stahlseele
Herkules 16 mm, 4-strand, PES with steel core
-  Edelstahl V2A
V2A stainless steel
-  2,50 x 4,00 m
-  110 kg, 230 x 100 x 30 cm
5 PCS/Packing Unit, 550 kg, 230 x 100 x 160 cm



MINI-RAUPENSCHAUKEL
MINI CATERPILLAR SWING
ART. 01140270

WEITERE FARBEN
AUF ANFRAGE!
OTHER COLOURS
ON REQUEST!



MAXI-RAUPENSCHAUKEL
MAXI CATERPILLAR SWING
ART. 01140520

	Fendex-Tauwerk 140 mm Quadrat Fendex-rope 140 mm, Square
	114,3 x 4 mm Stahlrohr, feuerverzinkt, pulverbeschichtet, hot-dip galvanised, powder-coated
	2,85 x 1,35 m  1,45 m
	Herkules 16 mm, 4-schäftig, PES mit Stahlseele Herkules 16 mm, 4-strand, PES with steel core
	Edelstahl V2A V2A stainless steel
	8,00 x 1,75 m
	165 kg, 230 x 100 x 30 cm

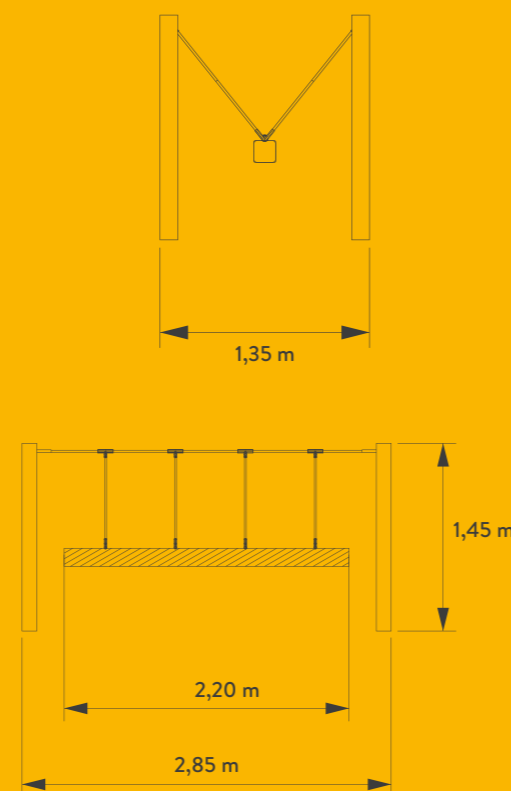

	Fendex-Tauwerk 140 mm Quadrat Fendex-rope 140 mm, Square
	88,9 x 2,9 mm Stahlrohr, feuerverzinkt, Pulverbeschichtung nur auf Anfrage Steel pipe, hot-dip galvanised, powder-coated on request
	7,20 x 3,98 m  4,28 m
	Herkules 16 mm, 4-schäftig, PES mit Stahlseele Herkules 16 mm, 4-strand, PES with steel core
	Edelstahl V2A V2A stainless steel
	14,00 x 4,00 m
	Tampen (Rope): 120 kg, 130 x 130 x 40 cm Gestell (Swing Frame): 600 kg, 730 x 230 x 110 cm

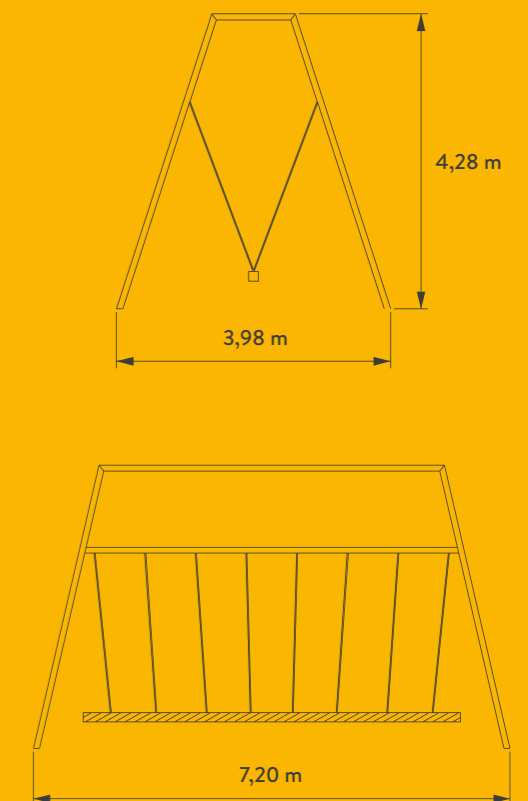











SCHAUKELTAMPEN
ROPE SWING
ART. 012401402

SCHAUKELGESTELL
SWING FRAME
ART. 0190



TYP FENDEX 140 MM SQUARE
ART. 2401400

TYP PP 150 MM
ART. 022401500

	Fendex-Tauwerk 140 mm Quadrat Fendex-rope 140 mm, Square		80 x 80 x 6 mm, 88,9 x 2,9 mm Stahlrohr, feuerverzinkt, Pulverbeschichtung nur auf Anfrage Steel pipe, hot-dip galvanised, powder-coated on request
	4,50 m		2,50 m Kopfbalkenhöhe Height of head-beam
	2,50 m		3,55 x 1,75 m
	40 kg, 120 x 120 x 20 cm		180 kg, 360 x 100 x 30 cm

 Balanciertampfen werden standardmäßig mit Ringmutter M 16 an beiden Enden sowie Schrumpfschlauch ausgerüstet.

Balance ropes are equipped with shrink-tube and M 16 eye-nuts at both ends as standard.

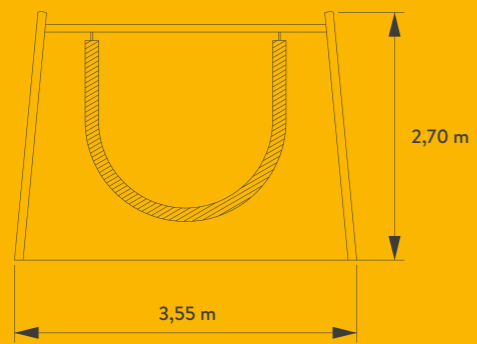

Gerne fertigen wir auch Balanciertampfen nach Ihren Vorgaben. Bitte fragen Sie uns.
We produce balance ropes according to your specifications. Please contact us.





TAMPENSCHAUKEL TRIO
ROPE SWING TRIO
 ART. 02140250 (Abbildung oben)



FEDERWIPPENEST
ROCKING SEESAW-NEST
 ART. 01820

-  Fendex-Tauwerk 140 mm Quadrat
Fendex-rope 140 mm, Square
-  Herkules 16 mm, 4-schäftig,
PES mit Stahlseele
Herkules 16 mm, 4-strand, PES with steel core
-  UNO 0,80 m
DUO 1,82 m
TRIO 2,50 m
-  3,00 m
MAX
-  Edelstahl V2A
V2A stainless steel
-  UNO 20 kg, 90 x 20 x 20 cm
DUO 42 kg, 125 x 20 x 20 cm
TRIO 62 kg, 150 x 40 x 20 cm

TAMPENSCHAUKEL DUO
ROPE SWING DUO
 ART. 02140182



TAMPENSCHAUKEL UNO
ROPE SWING UNO
 ART. 02140080

 Usacord Longlife (16 mm),
4-schäftig, PES mit Stahlseele
4-strand, PES with steel core

 Stahlrohr, feuerverzinkt
Steel pipe, hot-dip galvanised
Ø 1,20 m

 1,20 m

 0,85 m

 4,20 m

 120 kg, 120 x 120 x 170 cm

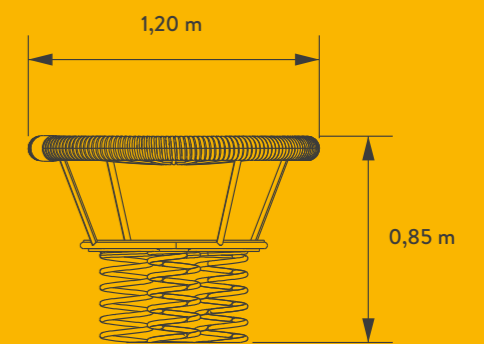



WOLKENTRÄUMER
CLOUD DREAMER
 ART. 0119012011

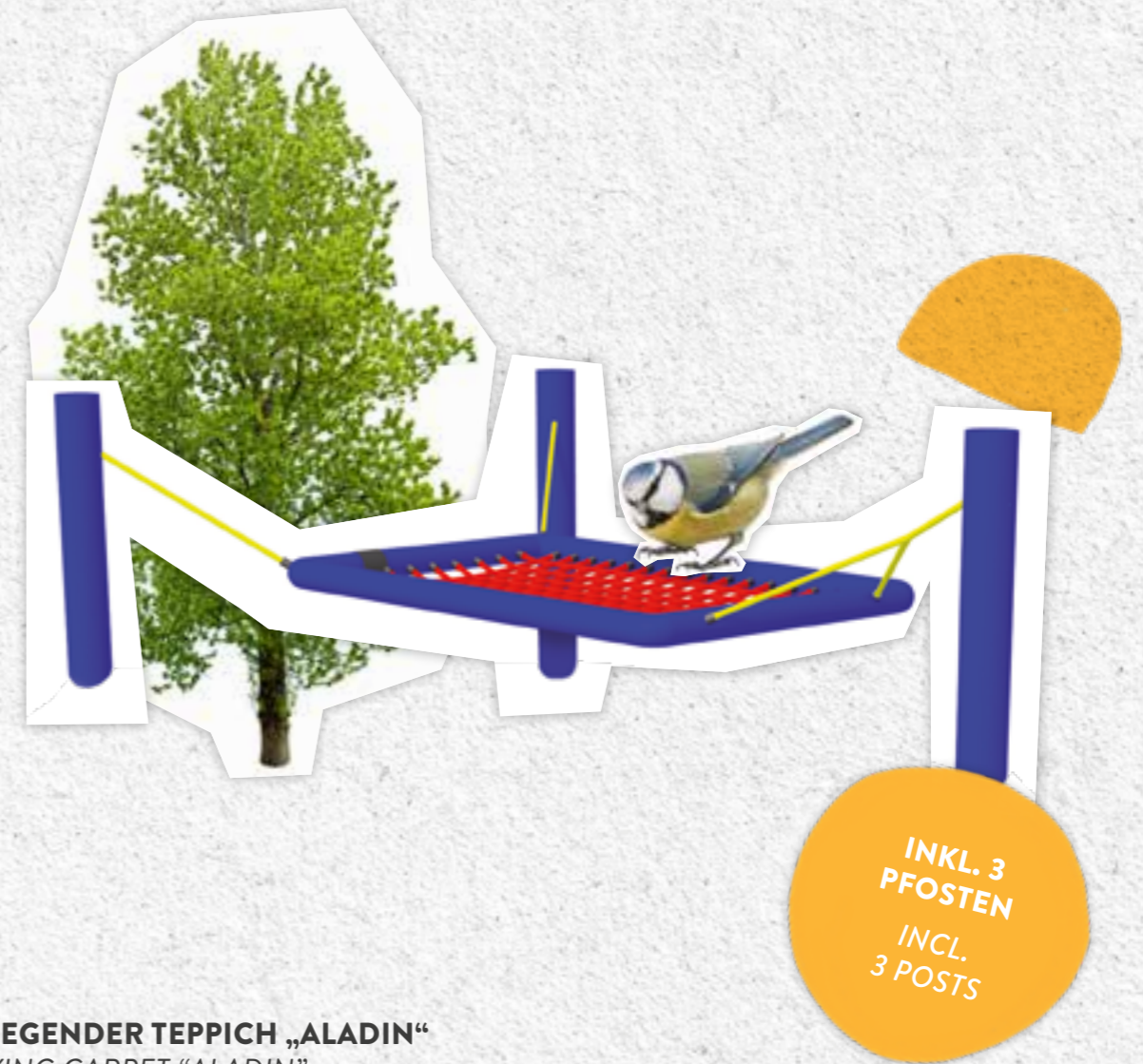

FLIEGENDER TEPPICH „ALADIN“
FLYING CARPET „ALADIN“
 ART. 01190120

	Usacord Longlife (16 mm), 4-schäftig, PES mit Stahlseele 4-strand, PES with steel core
	1,90 x 1,20 m Rechteckig Rectangular
	3,00 m
	Herkules 16 mm, 4-schäftig, PES mit Stahlseele Herkules 16 mm, 4-strand, PES with steel core
	Edelstahl V2A V2A stainless Steel
	70 kg, 190 x 10 x 120 cm



	Usacord Longlife (16 mm), 4-schäftig, PES mit Stahlseele 4-strand, PES with steel core		
	114,3 x 4 x 1900 mm Stahlrohr, feuerverzinkt, pulverbeschichtet Steel pipe, hot-dip galvanised, powder-coated		
	1,90 x 1,20 m Rechteckig Rectangular		3,27 x 2,29 m Rectangular
	1,05 m		
	Herkules 16 mm, 4-schäftig, PES mit Stahlseele Herkules 16 mm, 4-strand, PES with steel core		
	Kreuzgelenke Edelstahl V2A Universal joints stainless Steel V2A		
	6,30 x 5,30 m		
	110 kg, 190 x 120 x 40 cm		

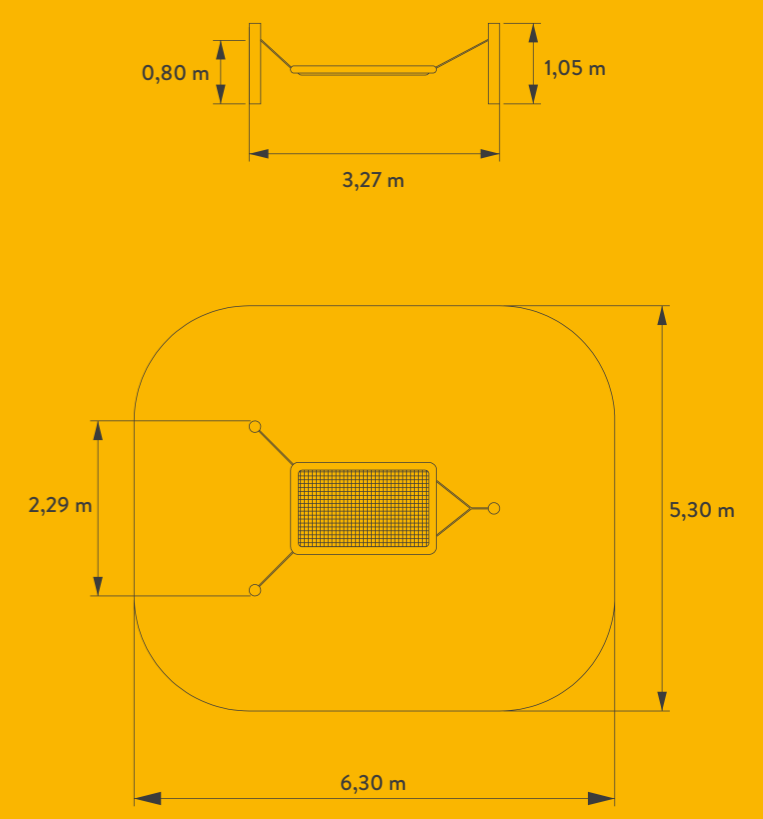



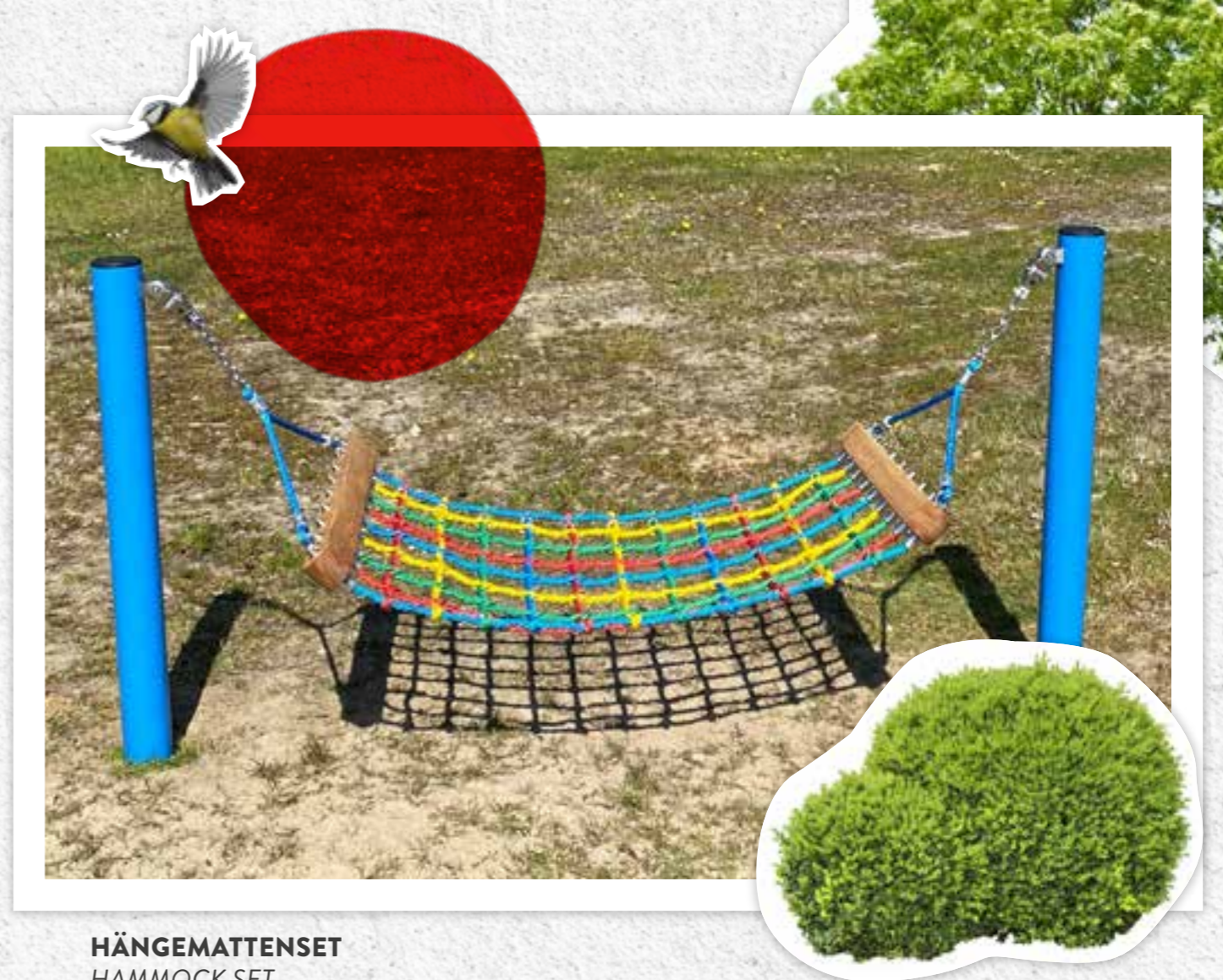

HÄNGEMATTE
HAMMOCK
ART. 02100200



HÄNGEMATTENSET
HAMMOCK SET
ART. 0280150230



-  Usacord Longlife (16 mm), 4-schäftig, PES mit Stahlseele
4-strand, PES with steel core
-  10 x 10 cm
-  2,00 x 1,00 m
-  Herkules 16 mm, 4-schäftig, PES mit Stahlseele, Länge nach Maß
Herkules 16 mm, 4-strand, PES with steel core, length according to your specifications
-  Edelstahl V2A
V2A stainless Steel
-  26 kg, 30 x 110 x 30 cm

Gerne fertigen wir Hängematten nach Ihren Vorgaben. Seilanschlüsse nach Wahl.
Bitte fragen Sie uns. Weitere Farben auf Anfrage!
Komplett vormontiert!

We produce hammocks according to your specifications. Fittings can be chosen. Please contact us. Other colours on request! Completely pre-installed!

-  Usacord Longlife (16 mm), 4-schäftig, PES mit Stahlseele
4-strand, PES with steel core
-  10 x 10 cm  1,50 x 0,80 m
-  114,3 x 4 x 1900 mm
Stahlrohr, feuerverzinkt, blau pulverbeschichtet
Steel pipe, hot-dip galvanised, blue powder-coated
-  Herkules 16 mm, 4-schäftig, PES mit Stahlseele
Herkules 16 mm, 4-strand, PES with steel core
-  Edelstahl V2A
V2A stainless steel
-  5,75 x 3,90 m
-  90 kg, 230 x 100 x 30 cm

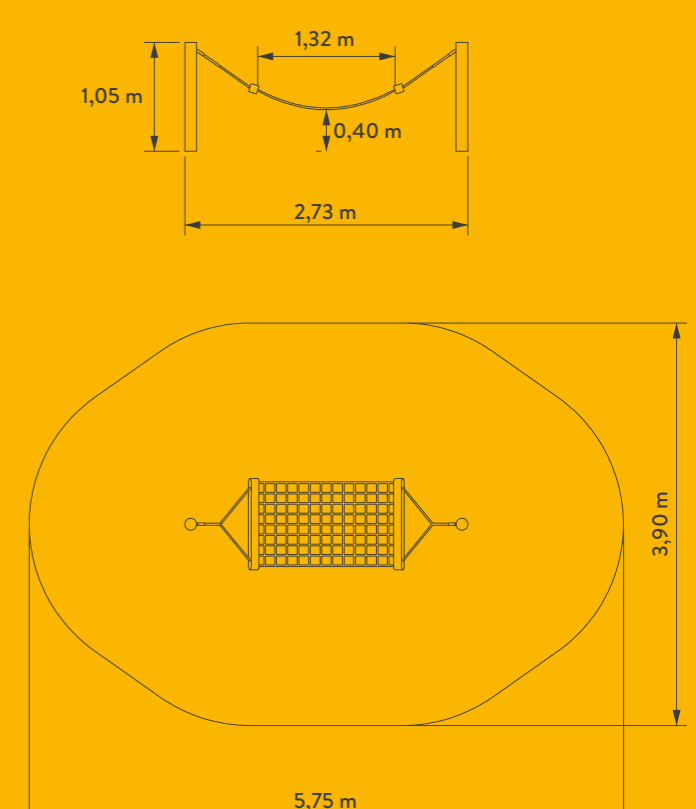

SPRUNGGERÄTE

BOUNCING ELEMENTS

HÜPF HÄSCHEN, HÜPF!

Hier geht es um Rhythmus und Körpergefühl und ganz viel Spaß! Ob rund oder eckig, in schwarz oder bunt – unsere Sprunggeräte sind die Attraktion auf jedem Spielplatz und erfüllen dabei höchste sicherheitstechnische Anforderungen. Ein speziell entwickelter Fallschutz, auch an den Innenkanten, sorgt für extra sicheres Spielen. Mit einem besonders stabilen Rahmen aus Stahl und bereits komplett einbaufertig vormontiert sind unsere Sprunggeräte nicht nur sehr robust, sondern auch montage- und wartungsfreundlich. Mittels unseres intelligenten Werkzeuges lassen sich die Sprungmatten einfach herausnehmen und sind wie auch die Fallschutzplatten in zahlreichen fröhlichen Farben und Designs erhältlich.

ROBUST UND WARTUNGS-FREUNDLICH:

- Montagefreundlich: werkseitig komplett vormontiert
- Leichtes Handling dank Wartungswerkzeug, leicht zu reinigen
- Rundum-Fallschutz an allen Kanten
- Flexible Farbgestaltung: Farben für Sprungmatte und Fallschutz wählbar
- Stabiler Stahlrahmen für Sicherheit und Langlebigkeit
- Kurze Lieferzeiten

HOP, BUNNY, HOP!

It's all about rhythm and body awareness and lots of fun! Whether round or square, in black or colourful - our bouncers are the attraction on every playground and meet the highest safety requirements. A specially developed fall protection, also on the inner edges, ensures extra safe play. With a particularly stable frame made of steel and already completely pre-assembled and ready for installation, our jumping equipment is not only very robust, but also easy to assemble and maintain. Using our sophisticated maintenance tool, the jumping mats can be easily removed and, like the fall protection slabs, are available in numerous cheerful colours and designs.

ROBUST AND EASY TO MAINTAIN:

- Easy to install: completely pre-assembled at the factory
- Easy to handle thanks to maintenance tool, easy to clean
- All-round fall protection on all edges
- Large variety of colour designs: Colours for jumping mat and fall protection can be selected
- Stable steel frame for safety and durability
- Short delivery times

JUMP R JUMP 6 JUMP CIRCLE S JUMP CIRCLE L JUMP XS JUMP S JUMP M JUMP L JUMP XL JUMP HIGHWAY





**+BUNTE
FULL-SIZE-LAMELLEN
+COLOURED
FULL-SIZE-SLATS**

**+ BUNTE
FALLSCHUTZPLATTEN
+ COLOURED
SAFETY SLABS**

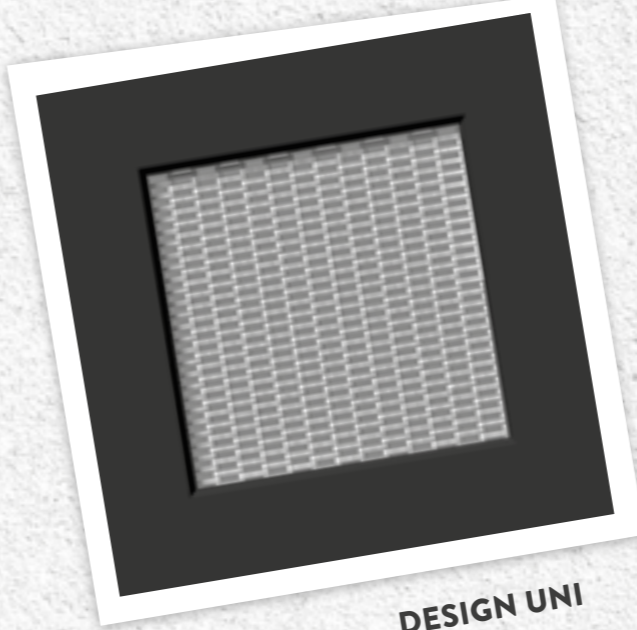

DESIGN UNI

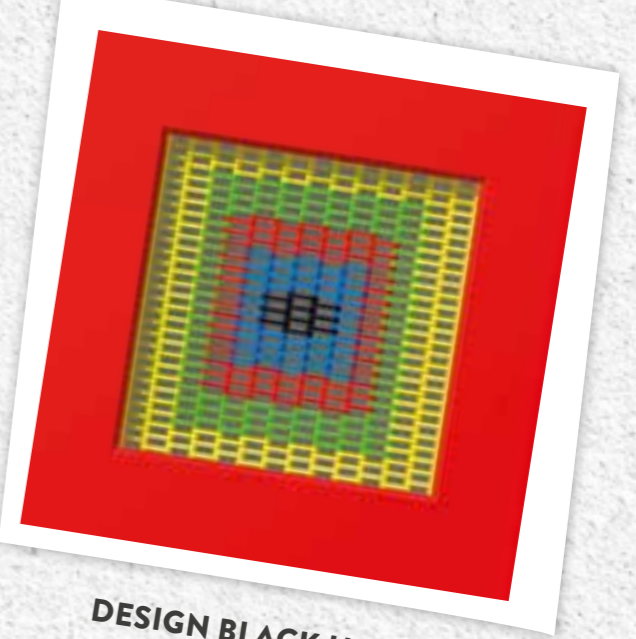

DESIGN BLACK HOLE

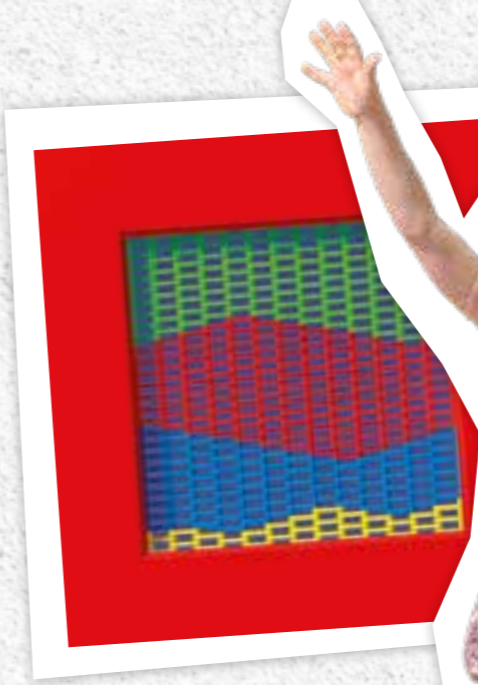

DESIGN WAVE

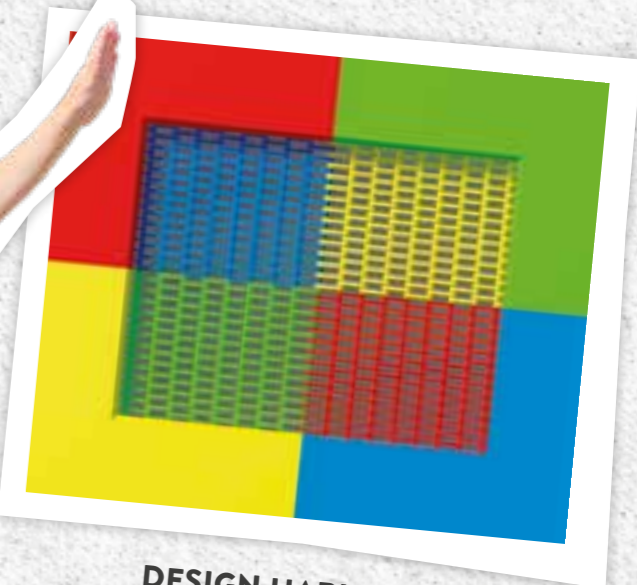

DESIGN HARLEKIN



**WARTUNGSWERKZEUG
MAINTENANCE HOOK TOOL
ART. 8182**

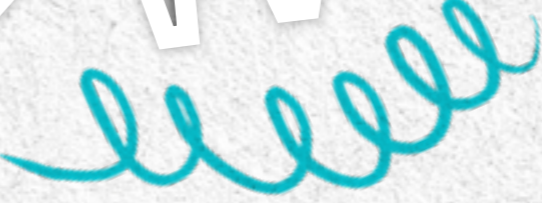

UNI
Erhältlich für alle Sprunggeräte
Available for all bouncing elements

WAVE
Erhältlich für / *Available for*
Jump XS, S, M, L, XL

BLACK HOLE
Erhältlich für / *Available for*
Jump XS, M, L, Circle S, Circle L

HARLEKIN
Erhältlich für / *Available for*
Jump XS, S, M, L, XL

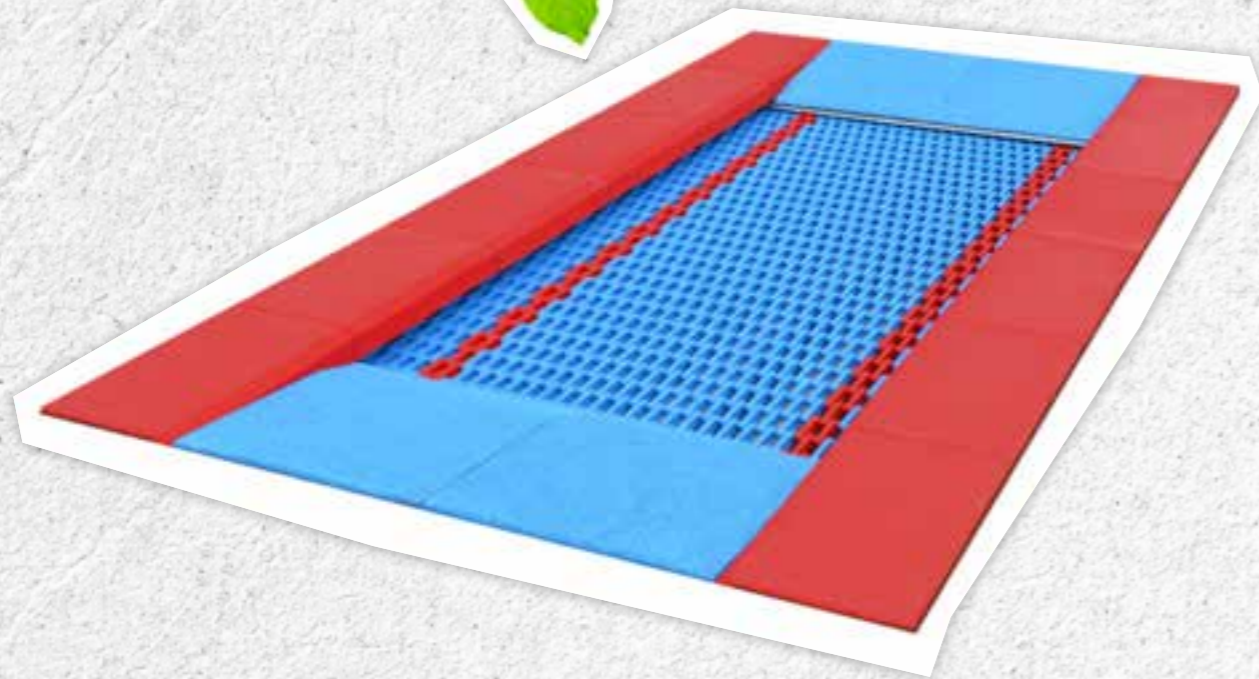

JUMP R
ART. 013300150

Rampen erleichtern den Zugang auch mit Rollstühlen.
Ramps facilitate access also for wheelchair users.



JUMP 6
ART. 013200175

-  3,00 x 1,50 m
-  2,00 x 1,00 m
Kunststofflamellen, robust und geriffelt
Synthetic material slat, robust and ridged
-  Stahl, feuerverzinkt, oben mit Fallschutzplatten nach DIN EN 1177 ausgerüstet
Steel, hot-dip galvanised, equipped with safety slabs plates according to DIN EN 1177
-  Stahlblech, verzinkt, komplett vormontiert
Sheet steel, galvanised, completely assembled
-  6,50 x 5,00 m
-  403 kg, 300 x 150 x 55 cm
4 PCS/Packing Unit, 1612 kg,
300 x 150 x 220 cm

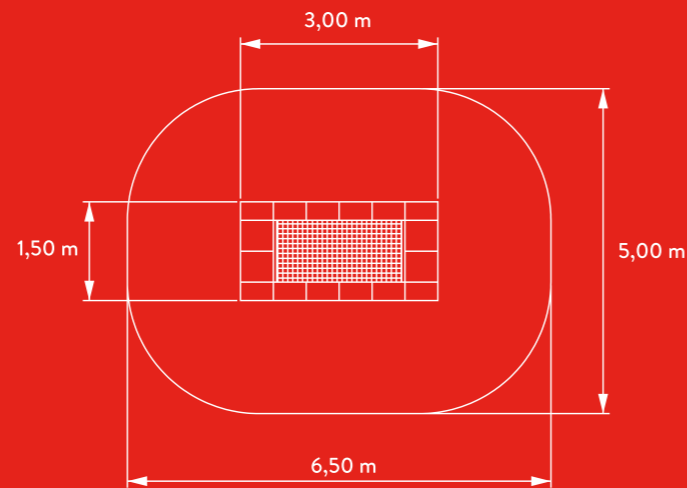

-  2,00 x 1,75 m
-  Ø 1,25 m
Kunststofflamellen, robust und geriffelt
Synthetic material slat, robust and ridged
-  Stahl, feuerverzinkt, oben mit Fallschutzplatten nach DIN EN 1177 ausgerüstet
Steel, hot-dip galvanised, equipped with safety slabs plates according to DIN EN 1177
-  Stahlblech, verzinkt, komplett vormontiert
Sheet steel, galvanised, completely assembled
-  4,50 x 4,30 m
-  330 kg, 200 x 175 x 55 cm
4 PCS/Packing Unit, 1320 kg,
200 x 175 x 220 cm

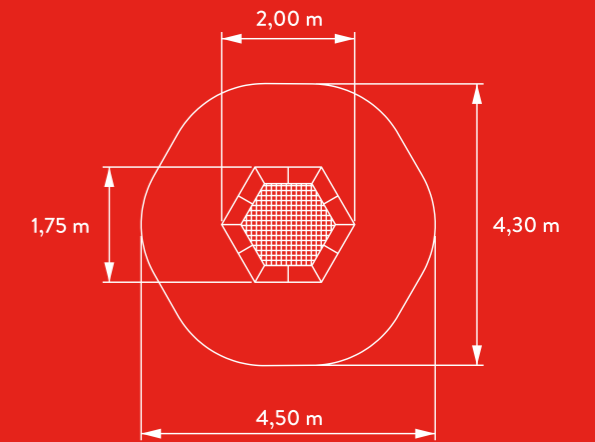





JUMP CIRCLE S
ART. 013170

JUMP CIRCLE L
ART. 013240

 1,70 m

 Ø 1,20 m
Kunststofflamellen, robust und geriffelt
Synthetic material slat, robust and ridged

 Stahl, feuerverzinkt, oben mit Fallschutzplatten nach DIN EN 1177 ausgerüstet
Steel, hot-dip galvanised, equipped with safety slabs plates according to DIN EN 1177

 Stahlblech, verzinkt, komplett vormontiert
Sheet steel, galvanised, completely assembled

 Ø 4,20 m

 213 kg, 170 x 170 x 55 cm
4 PCS/Packing Unit, 852 kg,
170 x 170 x 220 cm

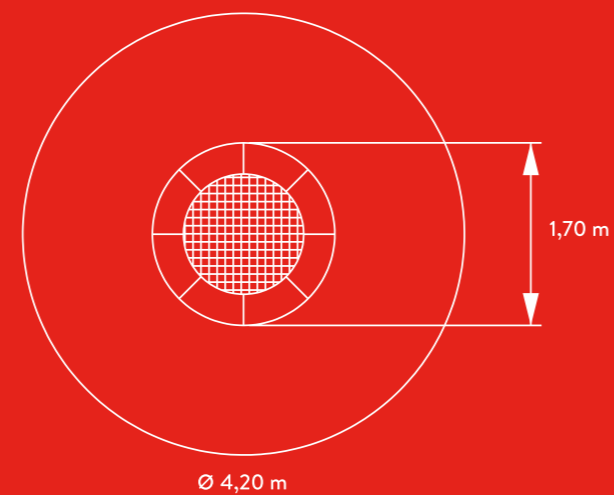

 2,40 m

 Ø 1,90 m
Kunststofflamellen, robust und geriffelt
Synthetic material slat, robust and ridged

 Stahl, feuerverzinkt, oben mit Fallschutzplatten nach DIN EN 1177 ausgerüstet
Steel, hot-dip galvanised, equipped with safety slabs plates according to DIN EN 1177

 Stahlblech, verzinkt, komplett vormontiert
Sheet steel, galvanised, completely assembled

 Ø 5,90 m

 390 kg, 245 x 245 x 55 cm
4 PCS/Packing Unit, 1560 kg,
245 x 245 x 220 cm

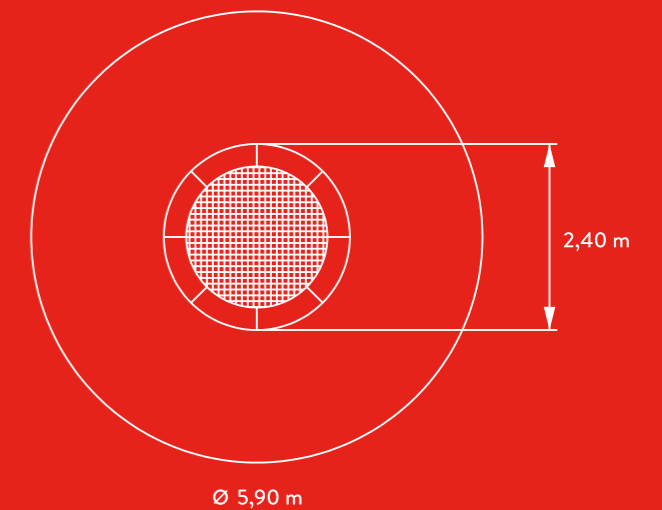

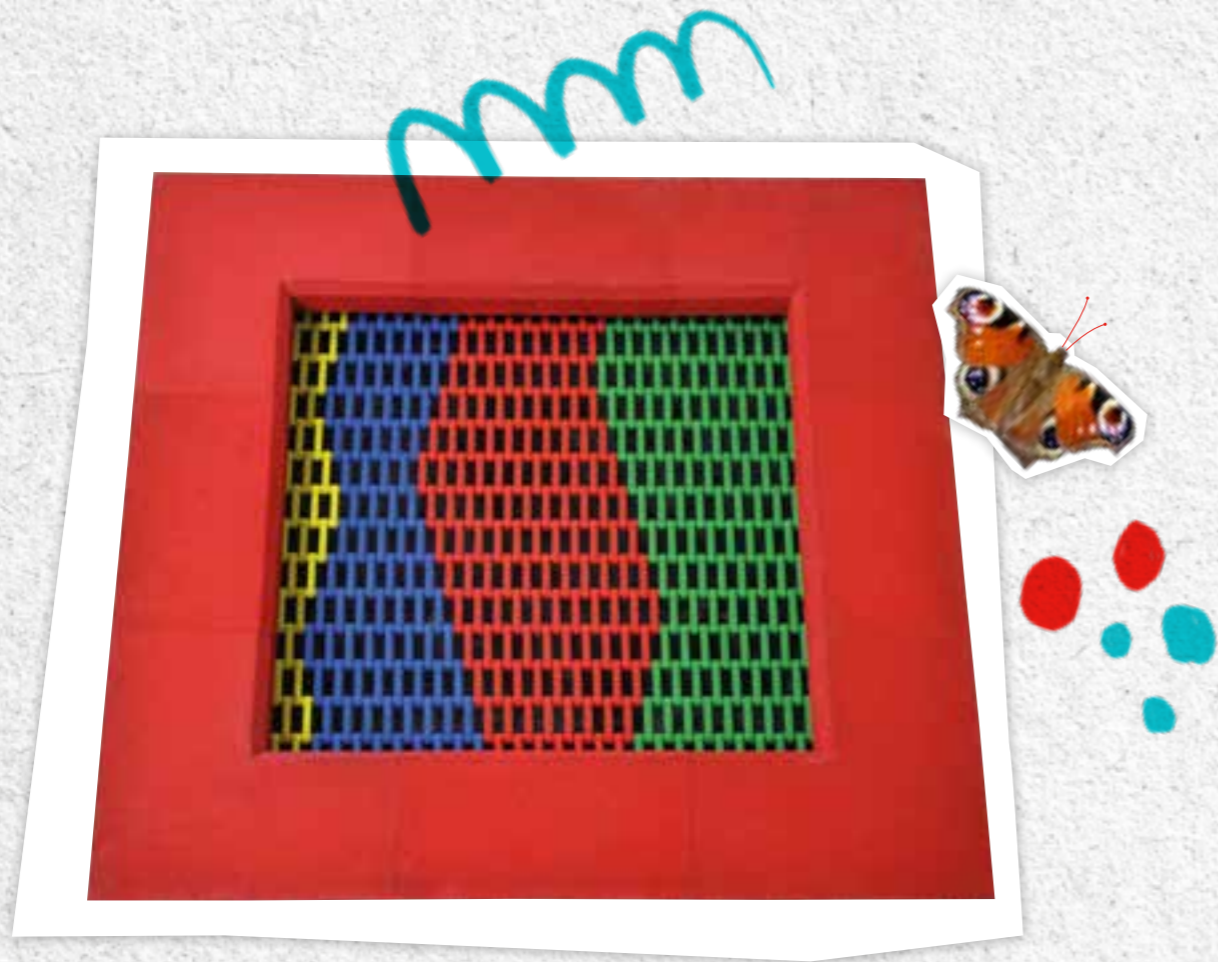



JUMP XS
ART. 013150150

JUMP S
ART. 013175150

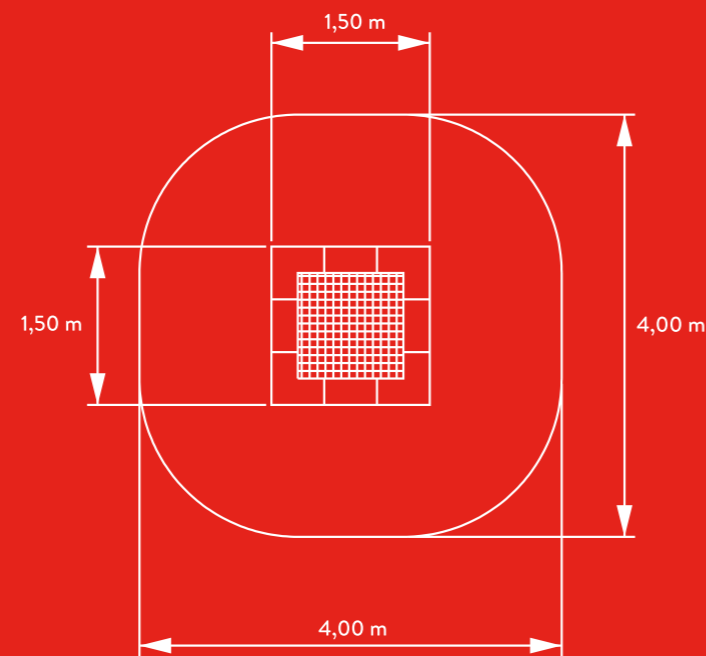
	1,50 x 1,50 m
	1,00 x 1,00 m Kunststofflamellen, robust und geriffelt Synthetic material slat, robust and ridged
	Stahl, feuerverzinkt, oben mit Fallschutzplatten nach DIN EN 1177 ausgerüstet Steel, hot-dip galvanised, equipped with safety slabs plates according to DIN EN 1177
	Stahlblech, verzinkt, komplett vormontiert Sheet steel, galvanised, completely assembled
	4,00 x 4,00 m
	208 kg, 150 x 150 x 55 cm 4 PCS/Packing Unit, 832 kg, 150 x 150 x 220 cm



	1,50 x 1,75 m
	1,00 x 1,25 m Kunststofflamellen, robust und geriffelt Synthetic material slat, robust and ridged
	Stahl, feuerverzinkt, oben mit Fallschutzplatten nach DIN EN 1177 ausgerüstet Steel, hot-dip galvanised, equipped with safety slabs plates according to DIN EN 1177
	Stahlblech, verzinkt, komplett vormontiert Sheet steel, galvanised, completely assembled
	4,25 x 4,00 m
	220 kg, 150 x 175 x 55 cm 4 PCS/Packing Unit, 880 kg, 150 x 175 x 220 cm

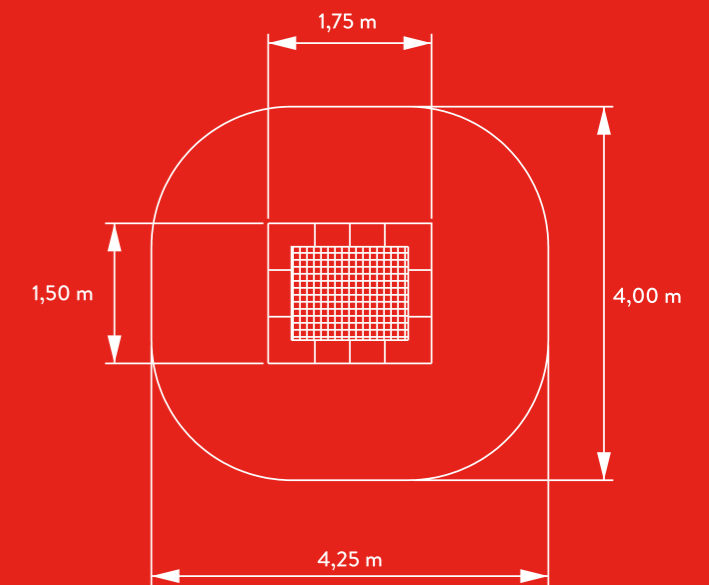



JUMP M
ART. 013200200



JUMP L
ART. 013250250

-  2,00 x 2,00 m
-  1,50 x 1,50 m
Kunststofflamellen, robust und geriffelt
Synthetic material slat, robust and ridged
-  Stahl, feuerverzinkt, oben mit Fallschutzplatten nach DIN EN 1177 ausgerüstet
Steel, hot-dip galvanised, equipped with safety slabs plates according to DIN EN 1177
-  Stahlblech, verzinkt, komplett vormontiert
Sheet steel, galvanised, completely assembled
-  5,50 x 5,50 m
-  300 kg, 200 x 200 x 55 cm
4 PCS/Packing Unit, 1200 kg,
200 x 200 x 220 cm

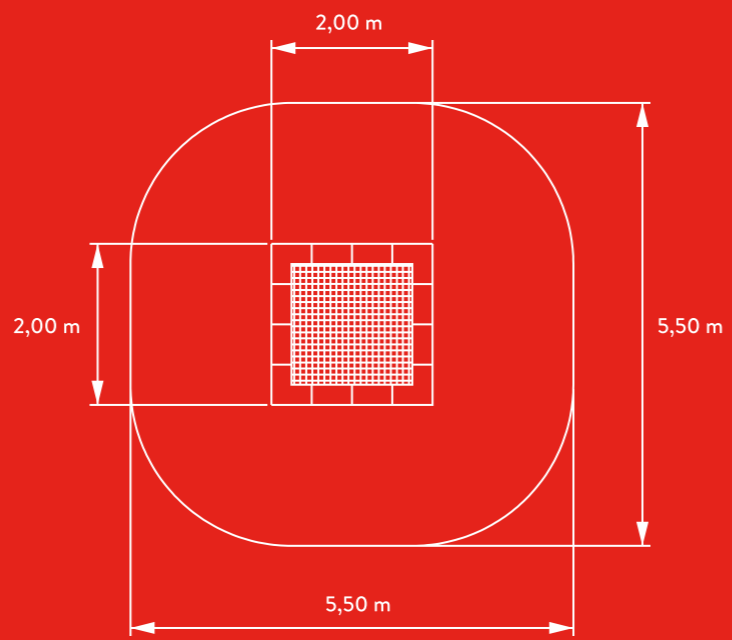

-  2,50 x 2,50 m
-  2,00 x 2,00 m
Kunststofflamellen, robust und geriffelt
Synthetic material slat, robust and ridged
-  Stahl, feuerverzinkt, oben mit Fallschutzplatten nach DIN EN 1177 ausgerüstet
Steel, hot-dip galvanised, equipped with safety slabs plates according to DIN EN 1177
-  Stahlblech, verzinkt, komplett vormontiert
Sheet steel, galvanised, completely assembled
-  6,00 x 6,00 m
-  365 kg, 250 x 250 x 55 cm
4 PCS/Packing Unit, 1460 kg,
250 x 250 x 220 cm

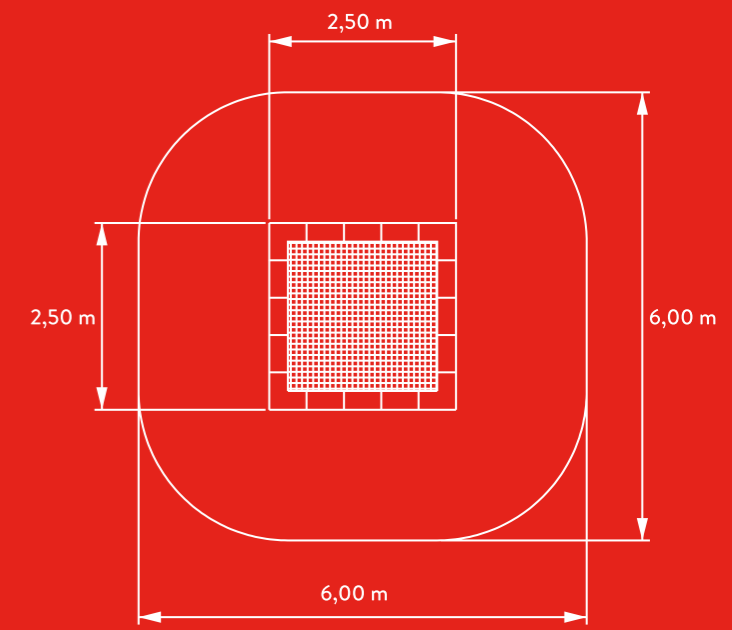

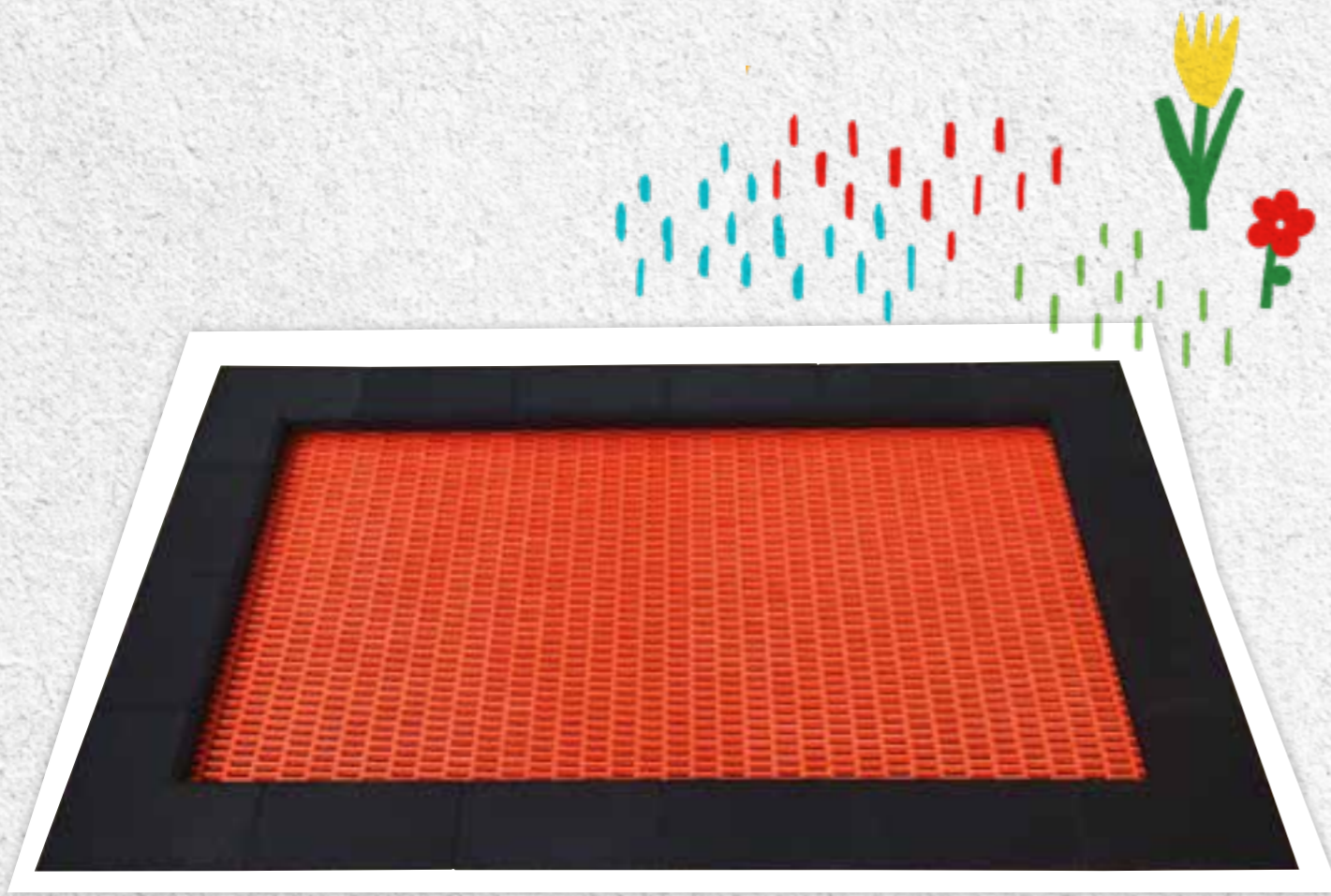

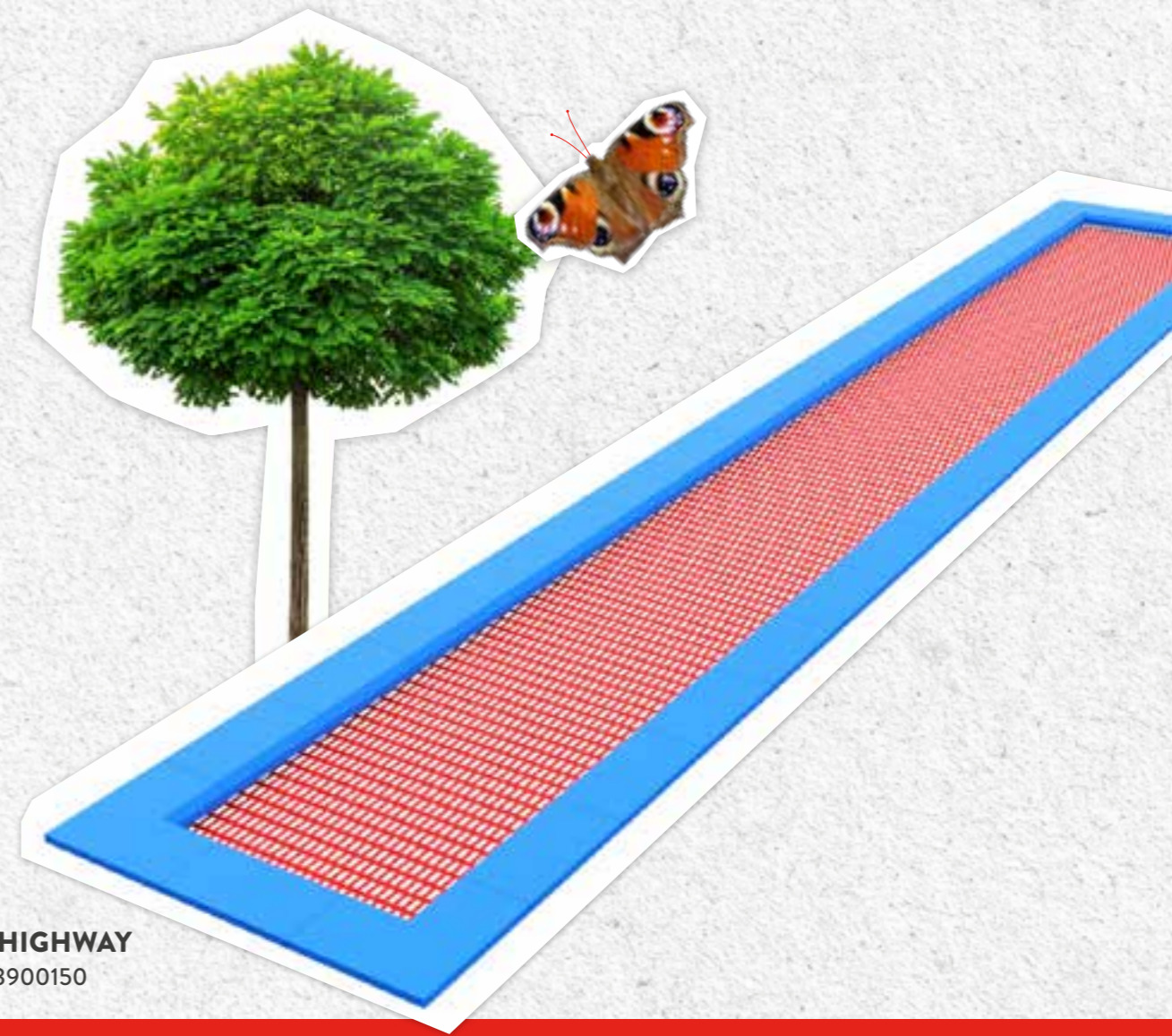

JUMP XL
ART. 013300200



JUMP HIGHWAY
ART. 013900150

 3,00 x 2,00 m

 2,50 x 1,50 m
Kunststofflamellen, robust und geriffelt
Synthetic material slat, robust and ridged

 Stahl, feuerverzinkt, oben mit Fallschutzplatten nach DIN EN 1177 ausgerüstet
Steel, hot-dip galvanised, equipped with safety slabs plates according to DIN EN 1177

 Stahlblech, verzinkt, komplett vormontiert
Sheet steel, galvanised, completely assembled

 6,50 x 5,50 m

 362 kg, 300 x 200 x 55 cm
4 PCS/Packing Unit, 1448 kg,
300 x 200 x 220 cm

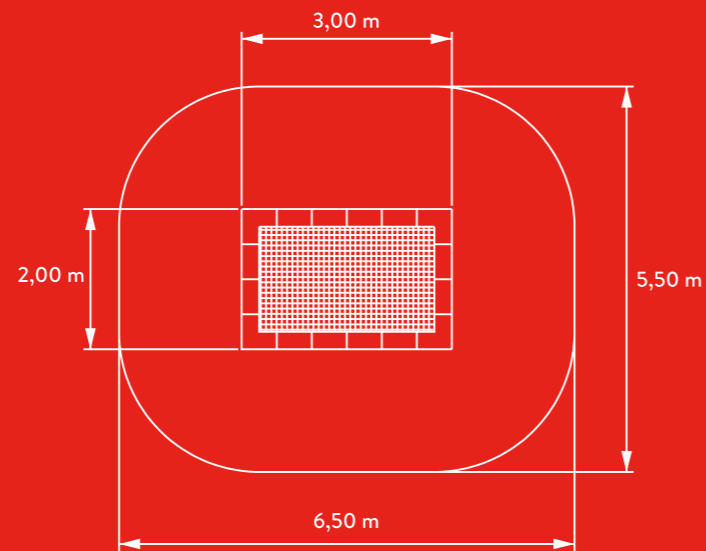

 9,00 x 1,50 m

 8,50 x 1,00 m
Kunststofflamellen, robust und geriffelt
Synthetic material slat, robust and ridged

 Stahl, feuerverzinkt, oben mit Fallschutzplatten nach DIN EN 1177 ausgerüstet
Steel, hot-dip galvanised, equipped with safety slabs plates according to DIN EN 1177

 Stahlblech, verzinkt, komplett vormontiert
Sheet steel, galvanised, completely assembled

 12,50 x 5,00 m

 1500 kg, 3 PCS/Packing Unit
300 x 150 x 165 cm

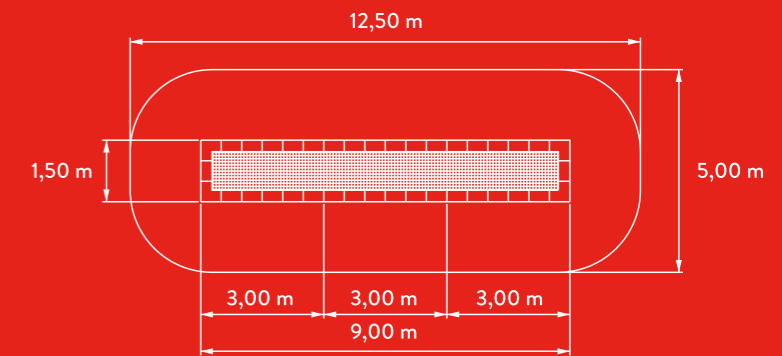

KLETTERNETZE

CLIMBING NETS

AN DIE NETZE, FERTIG, LOS!

Unsere beliebten Kletternetze sind echte Klassiker. Sich spielerisch austesten, Grenzen überwinden und Abenteuer erleben – dafür eignen sich die vielfältigen Ullmann-Kletternetze hervorragend. Ob als reines Kletternetz, Hängebrücke oder Netzunnel: hergestellt aus Herkules-Tauwerk, zeichnen sich die Netze nicht nur durch Sicherheit, hohen Spielwert, beste Qualität sowie durch ausgewiesene Wartungsfreundlichkeit aus. Sie überzeugen auch durch ihre enorme Anbindevielfalt. Sie sind auf der Suche nach einer besonderen Kletternetzlösung oder wünschen sich eine individuelle Farbgestaltung? Gerne unterstützt Sie unser kompetentes Team bei Ihren persönlichen Vorstellungen.

USACORD KLETTERNETZE – DAS ORIGINAL VON ULLMANN!

- Austauschbare Seile sowie Ersatzverbinder als Zubehör
- Herausragende Vielfalt an Anbindungsmöglichkeiten
- Individuelle Farbgestaltung und Netzlösungen nach Kundenwunsch
- Kompetente Beratung und technischer Service
- Vandalismussicher durch Herkules-Tauwerk
- Kurze Lieferzeiten

TO THE NETS, READY, GO!

Our popular climbing nets are real classics. Playfully testing yourself, overcoming limits and experiencing adventures - the versatile Ullmann climbing nets are perfect for this. Whether as a pure climbing net, hanging bridge or net tunnel: made of Herkules rope, the nets are not only characterised by safety, high play value, best quality and proven ease of maintenance. They also impress with their enormous variety of connections. Are you looking for a special climbing net solution or would you like an individual colour design? Our highly qualified team will be happy to assist you with your personal ideas.

USACORD CLIMBING NETS - THE ORIGINAL FROM ULLMANN!

- Exchangeable ropes and replacement connectors as accessories
- Outstanding variety of connection options
- Individual colour design and net solutions according to customer requirements
- Competent advice and technical service
- Vandalism-proof due to Herkules ropes
- Short delivery times



**AUF WUNSCH
AUCH 6-SCHÄFTIG
6-STRAND
ON DEMAND**

KLETTERNETZ MIT KUGELVERBINDER
CLIMBING NET WITH PLASTIC JOINTS

KLETTERNETZ GESPLEISST
CLIMBING NET, SPLICED





HÄNGEBRÜCKE
HANGING BRIDGE

 ART. 02250 MW 25 cm, Herkules 16 mm
4-schäftig, PES mit Stahlseele
4-strand, PES with steel core

 ART. 0225020 MW 25 cm, Herkules 20 mm
4-schäftig, PES mit Stahlseele
4-strand, PES with steel core

 ART. 02300 MW 30 cm, Herkules 16 mm
4-schäftig, PES mit Stahlseele
4-strand, PES with steel core

 ART. 0230020 MW 30 cm, Herkules 20 mm
4-schäftig, PES mit Stahlseele
4-strand, PES with steel core

 ART. 02125 MW 12,5 cm, Herkules 16 mm
4-schäftig, PES mit Stahlseele
4-strand, PES with steel core

 ART. 0210 MW 10 cm, Herkules 16 mm
4-schäftig, PES mit Stahlseele
4-strand, PES with steel core

 ART. 022508 MW 25 cm, Herkules 16 mm
4-schäftig, PES mit Stahlseele
4-strand, PES with steel core

 ART. 023008 MW 30 cm, Herkules 16 mm
4-schäftig, PES mit Stahlseele
4-strand, PES with steel core

 ART. 021258 MW 12,5 cm, Herkules 16 mm
4-schäftig, PES mit Stahlseele
4-strand, PES with steel core

 ART. 02108 MW 10 cm, Herkules 16 mm
4-schäftig, PES mit Stahlseele
4-strand, PES with steel core

 ART. 0215250 MW 25 cm, PP Spinnfaser 16 mm
4-schäftig, PP, gespleißt
4-strand, PP, spliced

 ART. 0215300 MW 30 cm, PP Spinnfaser 16 mm
4-schäftig, PP, gespleißt
4-strand, PP, spliced

 Herkules (16 mm),
4-schäftig, PES mit Stahlseele
4-strand, PES with steel core

 30 x 30 cm

 Holzspalten / Wooden Slats
750 x 50 x 75 mm

 Geländerhöhe / Railing height
0,80 m

 Kugelverbinder
Plastic joints

 Augenschrauben M 12,
Länge nach Ihren Anforderungen
M 12 eye-bolt,
length according to your specifications

LÄNGE / LENGTH

ART. 0316200	200 CM
ART. 0316250	250 CM
ART. 0316300	300 CM
ART. 0316400	400 CM

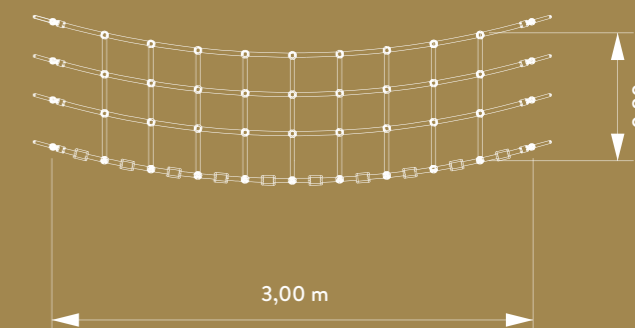





NETZTUNNEL
NET TUNNEL



NETZBRÜCKE
NET BRIDGE



 Herkules (16 mm),
4-schäftig, PES mit Stahlseele
4-strand, PES with steel core

 25 x 25 cm / 30 x 30 cm

 12,5 x 12,5 cm / 10 x 10 cm

 Kugelverbinder
Plastic joints

 Augenschrauben M 12,
Länge nach Ihren Anforderungen
M 12 eye-bolt,
length according to your specifications





Gerne fertigen wir nach Ihren Vorgaben.
Seilanschlüsse nach Wahl. Bitte fragen Sie uns.

We produce according to your specifications.
Fittings can be chosen. Please contact us.

 Herkules (16 mm),
4-schäftig, PES mit Stahlseele
4-strand, PES with steel core

 25 x 25 cm / 30 x 30 cm

 12,5 x 12,5 cm / 10 x 10 cm
Lauffläche
Walking area

 Geländerhöhe / Railing height
0,90 m

 Kugelverbinder
Plastic joints

 Augenschrauben M 12,
Länge nach Ihren Anforderungen
M 12 eye-bolt,
length according to your specifications

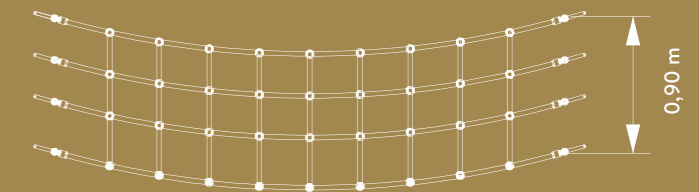



DSCHUNGELBRÜCKE

JUNGLE BRIDGE

ART. 033001205 | PP Ø 150 mm

ART. 033001212 | Fendex 140 mm Square



Herkules, 4-schäftig, PES mit Stahlseele
Herkules, 4-strand, PES with steel core



30 x 30 cm

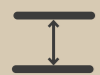

Geländerhöhe / Railing height
1,00 - 1,10 m



Kugelverbinder
Plastic joints



Augenschrauben M 12,
Länge nach Ihren Anforderungen
M 12 eye-bolts,
length according to your specifications

0,80 - 1,00 m

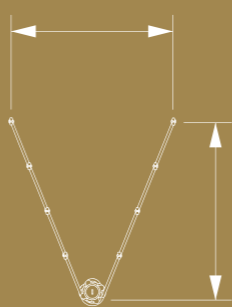

3,00 m

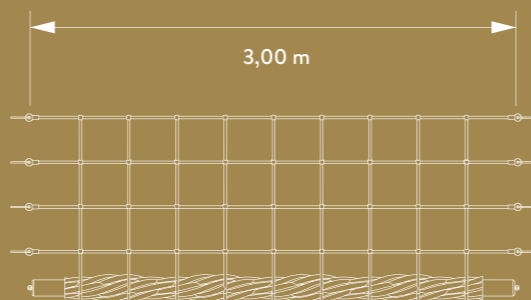

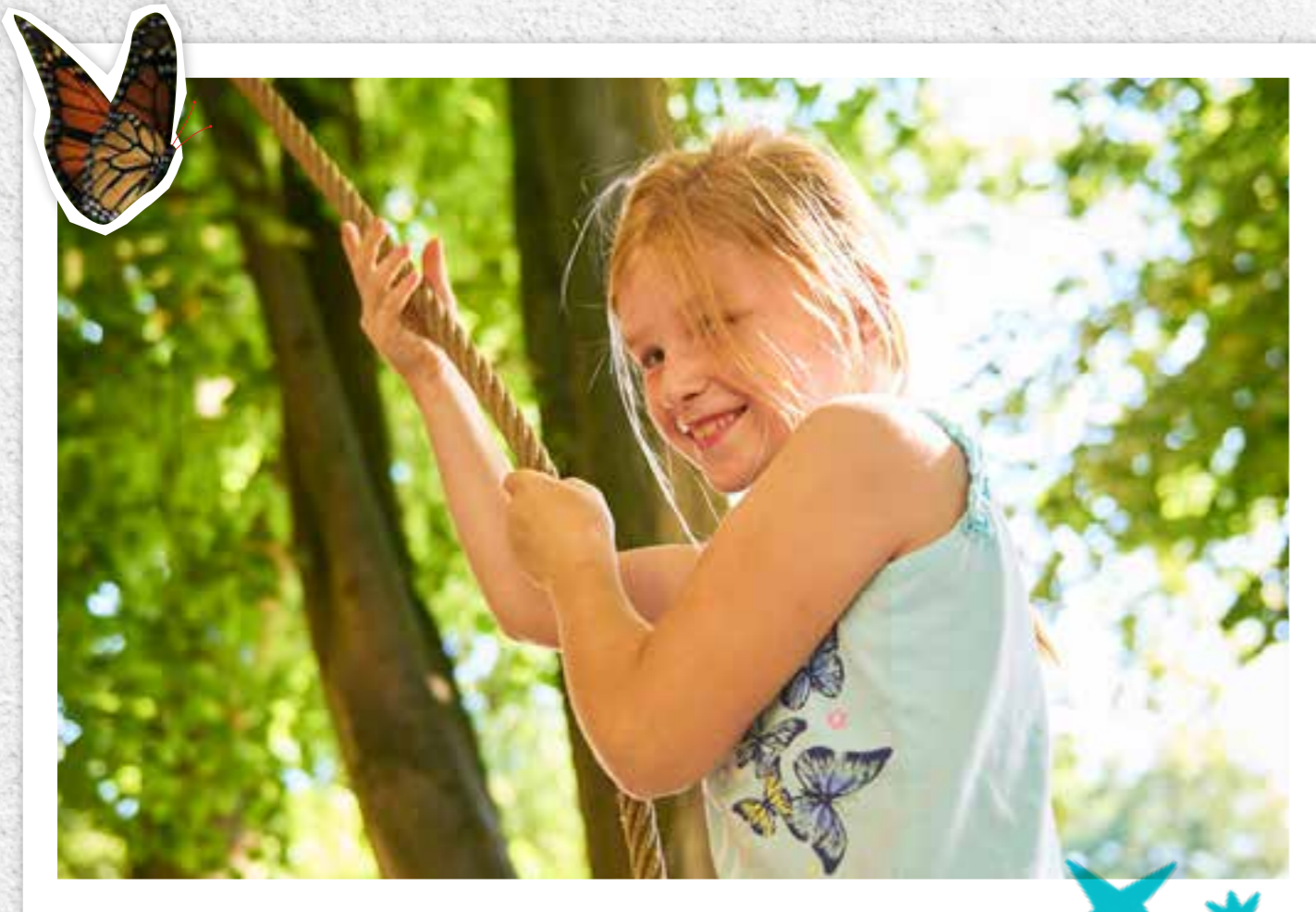

**IN DIVERSEN FARBEN
ERHÄLTlich. LÄNGE UND
ANSCHLÜSSE NACH
IHREN VORGABEN.
AVAILABLE IN VARIOUS
COLOURS, LENGTH AND
CONNECTIONS ACC. TO
YOUR SPECIFICATION.**

ART. 0416206	Klettertau Usacord Longlife 16 mm, 4-schäftig, PES mit Stahlseele, Länge nach Maß, Knoten alle 50 cm <i>Usacord Longlife climbing rope 16 mm, 4-strand, PES with steel core, length custom made, knots each 50 cm</i>
ART. 04182061	Klettertau Usacord Betelon 20 mm, 3-schäftig, PPM, Länge nach Maß, Knoten alle 50 cm <i>Usacord Betelon climbing rope 20 mm, 3-strand, PPM, length custom made, knots each 50 cm</i>
ART. 04182041	Hangeltau Usacord Betelon 20 mm, 3-schäftig, PPM, Länge 200 cm <i>Usacord Betelon climbing rope 20 mm, 3-strand, PPM, length 200 cm</i>
ART. 0416204	Hangeltau Herkules, 16 mm, 4-schäftig, PES mit Stahlseele, Länge nach Maß <i>Herkules climbing rope, 16 mm, 4-strand, PES with steel core, length custom made</i>
ART. 0418204	wie oben, jedoch 18 mm <i>as above, but 18 mm</i>
ART. 0420204	wie oben, jedoch 20 mm <i>as above, but 20 mm</i>
ART. 0424204	wie oben, jedoch 24 mm <i>as above, but 24 mm</i>

**KLETTERTAU
MIT KNOTEN
CLIMBING ROPE
WITH KNOTS**



**KLETTERTAU MIT
KLETTERRKNOTEN
AUS KUNSTSTOFF
CLIMBING ROPE
WITH PLASTIC KNOTS**

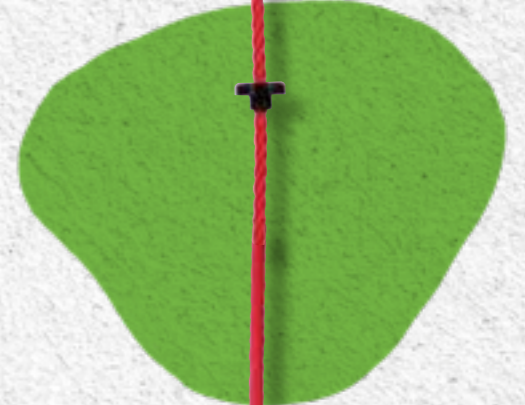

**HANGELTAU
CLIMBING ROPE**



**STRICKLEITER MIT HOLZSPROSSEN
ROPE LADDER WITH WOODEN RUNGS**

**STRICKLEITER MIT
KUNSTSTOFFSPROSSEN
ROPE LADDER WITH PLASTIC RUNGS**
ART. 0416203

HERKULES PES 16 MM

Breite der Sprossen: 40 cm
Width of the rungs: 40 cm

Sprossenabstand: 30 cm
Spacing between rungs: 30 cm

Länge und Anschlüsse nach
Ihren Vorgaben!
*Length and fittings according to
your specifications*

USACORD LONGLIFE SEILE GEDREHT
USACORD LONGLIFE ROPES TWISTED

Sehr griffig und flexibel. Unzerschneidbar wie Stahl, dank der 4 integrierten und verleimten Stahlseile im Kern. 4-fach gedreht. Ideal für Spielgeräte auf öffentlichen Spielplätzen, vandalismussicher. UV-stabil. Material: Kern: Stahlseil, Mantel: Polyester multifilament hochfest. Farben: schwarz, blau, grün, rot, gelb, beige, silbergrau, orange.

Very grippy and flexible. Uncuttable like steel, thanks to the 4 integrated and glued steel ropes in the core. 4 strand twisted. Ideal for playground equipment on public playgrounds, vandallism-proof, UV-stable. Material: Core: steel rope / sheath: polyester multifilament high tenacity. Colours: black, blue, green, red, yellow, beige, silver-grey, orange.



03 05 07 08 06 15 10 04

Art.	Ø mm	daN
97501600xx02	16	2600

HERKULES TAUWERK GEDREHT
HERKULES ROPES TWISTED

Hohe Festigkeit und Stabilität. Die integrierten 6 Stahlseillitzen schützen das Seil gegen Vandalismus und durch die textile Oberfläche ist das Herkules Tauwerk griffig und angenehm in der Handhabung. Bestens geeignet für Spielplätze und andere Seilanlagen im öffentlichen Raum. UV-stabil. Material: Kern: Stahlseil, Mantel: Polyester multifilament hochfest. Farben: 16 mm schwarz, blau, grün, rot, gelb, beige, silber (grau); 18 mm, 20 mm und 24 mm rot, schwarz, grün, blau, beige.

High strength and stability. The 6 integrated steel ropes protect the rope against vandalism and by the textile surface the Herkules rope is very grippy and comfortable in use. Perfect for playgrounds and other rope installations in public areas. UV-resistant. Material: Core: steel rope / sheath: polyester multifilament high tenacity. Colours: 16 mm black, blue, green, red, yellow, beige, silvergrey / 18, 20 & 24 mm red, black, green, blue, beige.



03 05 07 08 06 15 10

Art.	Ø mm	daN
97661600xx02	16	3500
97661800xx02	18	4000
97662000xx02	20	5000
97662400xx02	24	5800



VERBINDUNGSTEILE FÜR HERKULES / USACORD LONGLIFE 16 MM
CONNECTING PARTS HERKULES / LONGLIFE 16 MM

Art. 869204

Kugelverbinder 1-teilig
Ball connector, one-part



Art. 869203

Kugelverbinder 2-teilig
Ball connector, two-part



Art. 869108

T-Verbinder
T-connector



Art. 869100

T-Verbinder GELENK
T-connector FLEXIBLE



Art. 869202

Kreuzverbinder
Cross connector



Art. 851010011

End-zu-End Verbinder
End2End connector



Art. 869461

Endverbinder für Kettenanschluss
Endconnector for Chain Connection



Art. 8560230

Edelstahl V2A Kette
 7 mm nach DIN EN 1176, Meterware
Stainless Steel V2A Chain 7mm DIN EN 1176, per meter





DIVERSE FARBMÖGLICHKEITEN ERHÄLTlich! UNZERSCHNEIDBAR.
VARIOUS COLOUR COMBINATIONS AVAILABLE! CAN'T BE CUT.

BEACH-VOLLEYBALLNETZ
 BEACH VOLLEYBALL NET
 ART. 02950100



USACORD BALANCIERSET «SLACK-LINE PREMIUM»
 USACORD BALANCING SET «SLACK-LINE PREMIUM»
 ART. 04162071

USACORD BALANCIERSET «SLACK-LINE-BASIC»
 USACORD BALANCING SET «SLACK-LINE-BASIC»
 ART. 04162072



Usacord Longlife - 950 x 100 cm
 PES mit Stahlseele
 PES with steel core



Rhombisch
 Rhombic
 10 cm



Kugelverbinder, schwarz
 Plastic joints, black



Edelstahl V2A
 V2A stainless steel



Herkules (16 mm),
 4-schäftig, PES mit Stahlseele, jeweils 2 St.
 Wantenspanner M 12, Pfostenabstand 11,15 m,
 Edelstahlrohr an beiden Netzseiten
 4-strand, PESwith steel core, each with 2 PCS.
 turnbuckles M 12, post distances of 11.15 m,
 stainless steel tube at both sides

PFOSTEN FÜR BEACH-VOLLEYBALLNETZ
 POSTS FOR BEACH VOLLEYBALL NET

Art. 864330
 152,4 x 4,5 x 3300 mm
 Stahlrohr, feuerverzinkt und blau pulverbeschichtet
 Steel pipe, hot dip galvanised, powder-coated blue

Art. 864331
 152,4 x 4,5 x 3300 mm
 Stahlrohr, feuerverzinkt
 Steel pipe, hot dip galvanised

1 Stück Spanngurt 50 mm, Länge 12 m, mit einseitiger Schlaufe, 1 Stück Spanngurt 50 mm, Länge 3m mit Ratsche auf einer Seite und Schlaufe auf der anderen Seite, Schutzhülle für Ratsche, 1 Stück Halteseil, 12 mm, Länge 20 m, Balancierseil mit Laufkugel, Tragenetzbeutel

1 piece tensioning strap 50 mm, length 12 m, with loop on one side, 1 piece tensioning strap 50 mm, length 3m with ratchet on one side and loop on the other side, Protection cover for the ratchet, 1 piece holding rope, 12 mm, length 20 m, Balancing rope with running ball, Carrying net bag

1 Stück Spanngurt 50 mm, Länge 7 m mit einseitiger Schlaufe, 1 Stück Spanngurt 50 mm, Länge 3m mit Ratsche auf einer Seite und Schlaufe auf der anderen Seite

1 piece tensioning strap 50 mm, length 7 m with loop on one side, 1 piece tensioning strap 50 mm, length 3 m with ratchet on one side and loop on the other side

GEMEINSAM FÜR SIE STARK

TOGETHER STRONG FOR YOU

Seilfabrik Ullmann GmbH
Ermlandstraße 79
D-28777 Bremen
Fon +49 (0) 421 69 038 - 8
Fax +49 (0) 421 69 038 - 75
info@seilfabrik-ullmann.de
www.usacord.de

Corderie Ullmann SàRL
5, rue de Gutenberg
F-68190 Ensisheim
Fon +33 (0) 389740104
Fax +33 (0) 389740135
corderie.ullmann@usacord.fr
www.usacord.fr

Seilfabrik Ullmann AG
Kirchbergstrasse 179
CH-3400 Burgdorf/ BE
Fon +41 (0) 344240381
Fax +41 (0) 344240382
burgdorf@usacord.com
www.usacord.ch

mamutec AG
Gaiserwaldstrasse 16
CH-9015 St. Gallen
Fon +41 (0) 713141080
Fax +41 (0) 713141088
info@mamutec.com
www.mamutec.com

Seilfabrik Ullmann AG
Gaiserwaldstrasse 16
CH-9015 St.Gallen/ SG
Fon +41 (0) 713141888
Fax +41 (0) 713141880
info@usacord.com
www.usacord.ch

Mamutec Hungary Kft.
Körösládányi út 0918/5
H-5500 Gyomaendröd
Fon +36 (0) 66 581 060
Fax +36 (0) 66 581 030
aruhaz@mamutec.hu
www.mamutec.hu

Seilfabrik Ullmann AG
Ringstrasse 37
CH-7000 Chur/GR
Fon +41 (0) 812866699
Fax +41 (0) 812866698
seilfabrik.chur@usacord.com
www.usacord.com



IMPRESSUM

HERAUSGEBER

Seilfabrik Ullmann GmbH
Ermlandstraße 79
28777 Bremen
GERMANY

Fon +49 (0) 421 - 69 038 - 8
Fax +49 (0) 421 - 69 038 - 75

info@seilfabrik-ullmann.de
www.usacord.de



SEILFABRIK ULLMANN
Usacord

VERKAUFSBEDINGUNGEN

Allen Lieferungen und Leistungen liegen ausschließlich unsere Allgemeinen Verkaufsbedingungen in der jeweils aktuell gültigen Fassung zugrunde. Diese werden auf Anfrage zusammen mit unserer Preisliste ausgehändigt.

Des Weiteren haben Sie die Möglichkeit, unsere Allgemeinen Verkaufsbedingungen als pdf-Datei von unserer Internetseite zu laden.

GENERAL TERMS AND CONDITIONS

All deliveries and services are exclusively based on our general terms and conditions of sale which are handed over on demand together with our price-list.

You can also download our General Terms and Conditions as a PDF file from our website.

READY, STEADY, PLAY!

Seilfabrik Ullmann GmbH

Ermlandstraße 79

28777 Bremen

Germany

Fon +49 (0) 421 69 038 - 8

Fax +49 (0) 421 69 038 - 75

info@seilfabrik-ullmann.de

www.usacord.de

Konzept & Design: clsr.me

People-Fotografie: momentkonnekte.de

